

ENGLISH

4S-0303-04E0

10 JUN 1998

HAMEG[®]
Instruments

**Oscilloscope
HM 303-4**

SERVICE-MANUAL

HM303-4



Service Manual
 Circuit Diagrams
 Adjustment Procedure
HM303-4

St. 100698 Hüb/goRR

Y-Preamplifier CH I (YP-Board)	4
Y-Preamplifier CH II (YP-Board)	5
Y-Intermediate Amplifier and Trigger Amplifier (YP-Board)	6
YPA-Board (Top side)	7
YPA-Board (Bottom side)	8
XY-Amplifier, YF-Amplifier, OS-Circuit	9
XY-Board (Top side)	10
XY-Board (Bottom side)	11
Sync.-Amplifier	12
Time base	13
Sweep-Generator	14
TB-Board	15
CRT-Board	16
CRT-Board (Top and Bottom side)	17
Power Supply (PS-Board)	18
PS-Board (Top side)	19
PS-Board (Bottom side)	20
Component tester, Calibrator	21
CCT-Board (Top and Bottom side)	22
Front-Control Board	23
Front-Control Board (Top and Bottom side)	24
ADJUSTMENT PROCEDURE	25

Specifications

Vertical Deflection

Operating modes: Channel I or II separate, both Channels (alternated or chopped), (Chopper frequency approx. 0.5MHz).

Sum or difference with Ch. I and Ch. II (both channels invertable).

XY-Mode: via channel I and channel II

Frequency range: 2xDC to 30MHz (-3dB)

Risetime: <12ns.

Overshoot≤1%.

Deflection coefficients: 12 calibrated steps from 5mV/div. to 20V/div. (1-2-5 sequence) with variable 2.5:1 up to **50V/div.**

Accuracy in calibrated position: ±3%

Y-expansion x5 (calibrated) to **1mV/div.** (±5%) in the frequency range from DC - 10MHz (-3dB)

Input impedance: 1MΩ || 20pF.

Input coupling: DC-AC-GD (ground).

Input voltage: max. 400V (DC + peak AC).

Triggering

Automatic: (peak to peak) <20Hz-100MHz (≤0.5div.) Normal with level control: **DC-100MHz** (≤0.5div.)

ALT. Triggering; LED indicator for trigger action

Slope: positive or negative,

Sources: Channel I or II, CH. I alternating CH II, line, external

Coupling: **AC** (10Hz to 100MHz),

DC (0 to 100MHz),

LF (0 to 1.5kHz)

Active TV-Sync-Separator (pos. and neg.)

External: ≥0.3_{pp} from 30Hz to 30MHz

Horizontal Deflection

Time coefficients: 20 calibrated steps

from 0.2s/div. - 0.1μs/div. in 1-2-5 sequence

Accuracy in calibrated position: ±3%.

Min. speed incl. variable 2.5:1 up to 0.5s/div.

with X-Mag. x10: ±5%; 10ns/div.: ±8%

Holdoff time: variable to approx. 10:1

Bandwidth X-amplifier: 0-3MHz (-3dB).

Input X-Amplifier via Channel II,

(sensitivity see Channel II specification)

X-Y phase shift: <3° below 220kHz.

Component Tester

Test voltage: approx. 6V_{rms} (open circuit).

Test current: approx. 5mA_{rms} (shorted).

Test frequency: approx. 50Hz

Test connection: 2 banana jacks 4mm Ø

One test lead is grounded (Safety Earth)

General Information

CRT: D14-364GY/123 or ER151-GH/-,

6" rectangular screen (8x10cm)

internal graticule

Acceleration voltage: approx 2000V

Trace rotation: adjustable on front panel

Calibrator: square-wave generator (t_r <4ns)

≈1kHz / 1MHz; Output: 0.2V ±1% and 2V

Line voltage: 100-240V AC ±10%, 50/60Hz

Power consumption: approx. 36 Watt at 50Hz.

Min./Max. ambient temperature: 0°C...+40°C

Protective system: Safety class I (IEC 1010-1)

Weight: approx. 5.6kg, color: techno-brown

Cabinet: **W** 285, **H** 125, **D** 380 mm

Lockable tilt handle



30MHz Standard Oscilloscope HM 303

Dual Channel, DC to 30MHz, 1mV/div.; Overscan Indicator

Time Base: 0.2s to 10ns/div.; Variable Holdoff; Alternate Triggering

Triggering: DC-100MHz; Auto Peak to Peak; Active TV-Sync-Separator

Additional Features: Component Tester, 1kHz/1MHz Calibrator

The new **HAMEG HM303** oscilloscope succeeds the HM203 (over 170,000 sold worldwide). The bandwidth has been extended from 20 to **30MHz**, the sweep rate increased to **10ns/div.** and improvements added to the already legendary **HAMEG** auto triggering system. The **HM303** is the ideal instrument for waveform display in the **DC to 100MHz** frequency range.

A key feature of this oscilloscope is the vertical amplifier's pulse fidelity, limiting overshoot to only 1%. The **HM303** offers a special fast rise time **1kHz/1MHz Calibrator**, permitting high quality probe compensation across the entire frequency range to ensure probe-tip thru to display integrity. An **Overscan Indicator** assists in vertical display amplitude and position adjustment.

The **HM303** is capable of triggering on input waveforms over **100MHz** and on signal levels as small as 0.5 division. **Alternate triggering** mode enables the display of two asynchronous signals simultaneously. An active **Video Sync-Separator** permits detailed examination of complex TV signal inputs. A well proven, built-in **component tester** is now equipped with a stabilized measuring voltage. The use of a switching type of power supply minimizes both weight and power consumption and universally accepts a wide range of input power line voltages, without the requirement to change jumpers or switch positions. The **HM303's** CRT is fully **mu-metal shielded** against outside magnetic fields.

HAMEG is setting new **price/performance** breakthroughs with the introduction of this fine oscilloscope. This performance packed scope will tempt all users to run it through its paces.

Screen photo of 1 MHz square wave signal

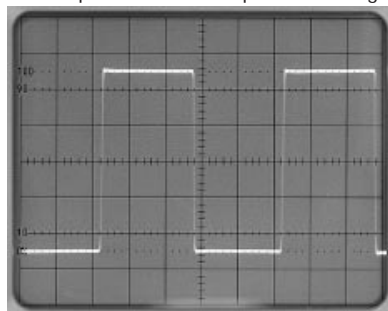

Screen photo of 50 and 100MHz sine wave with alternate triggering

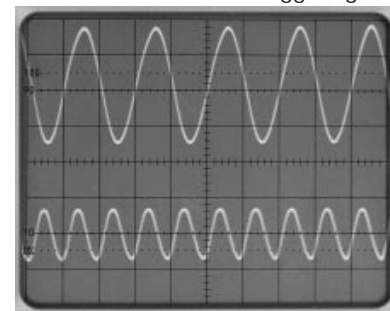

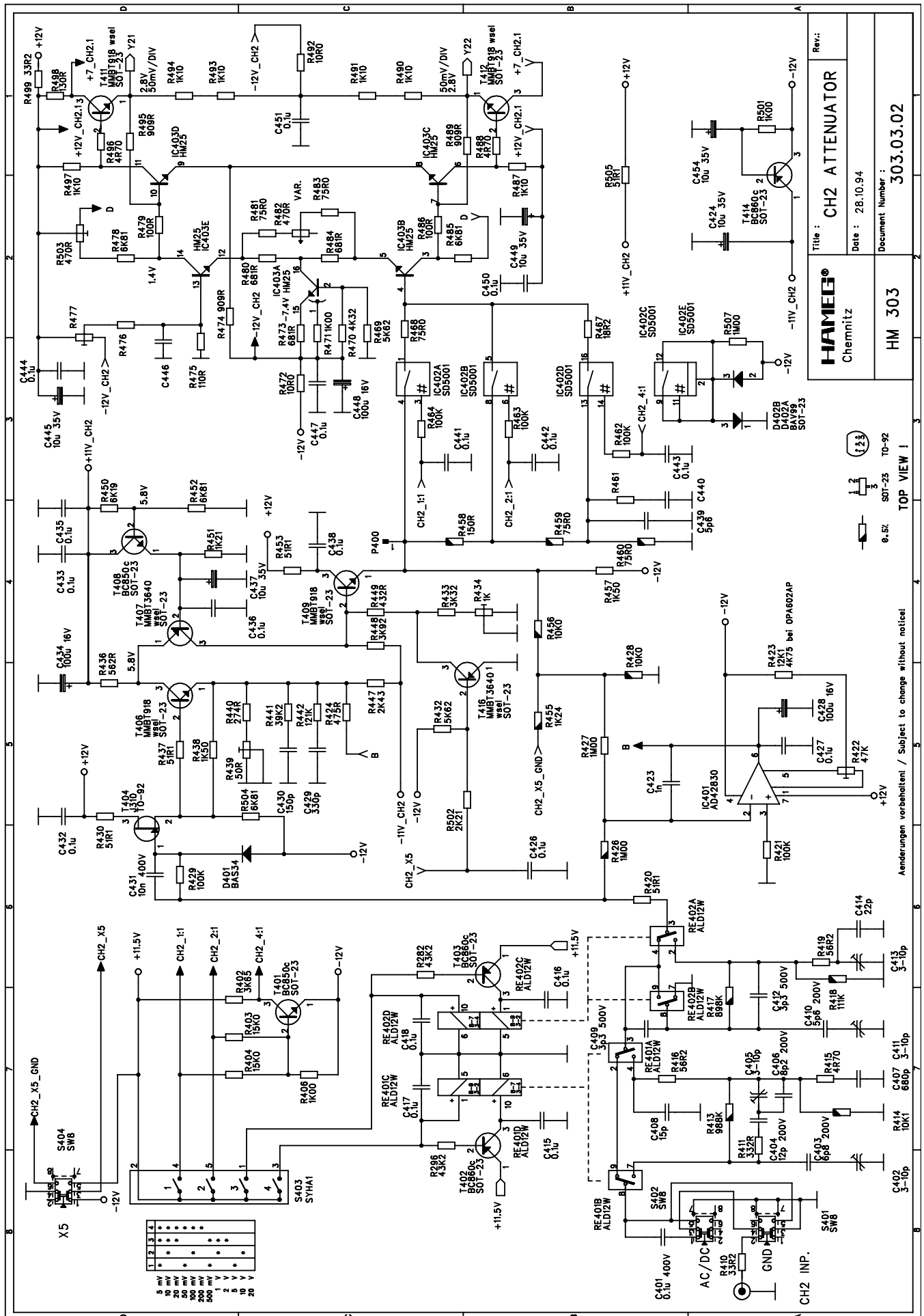

Y-Intermediate Amplifier and Trigger Amplifier (YP-Board)

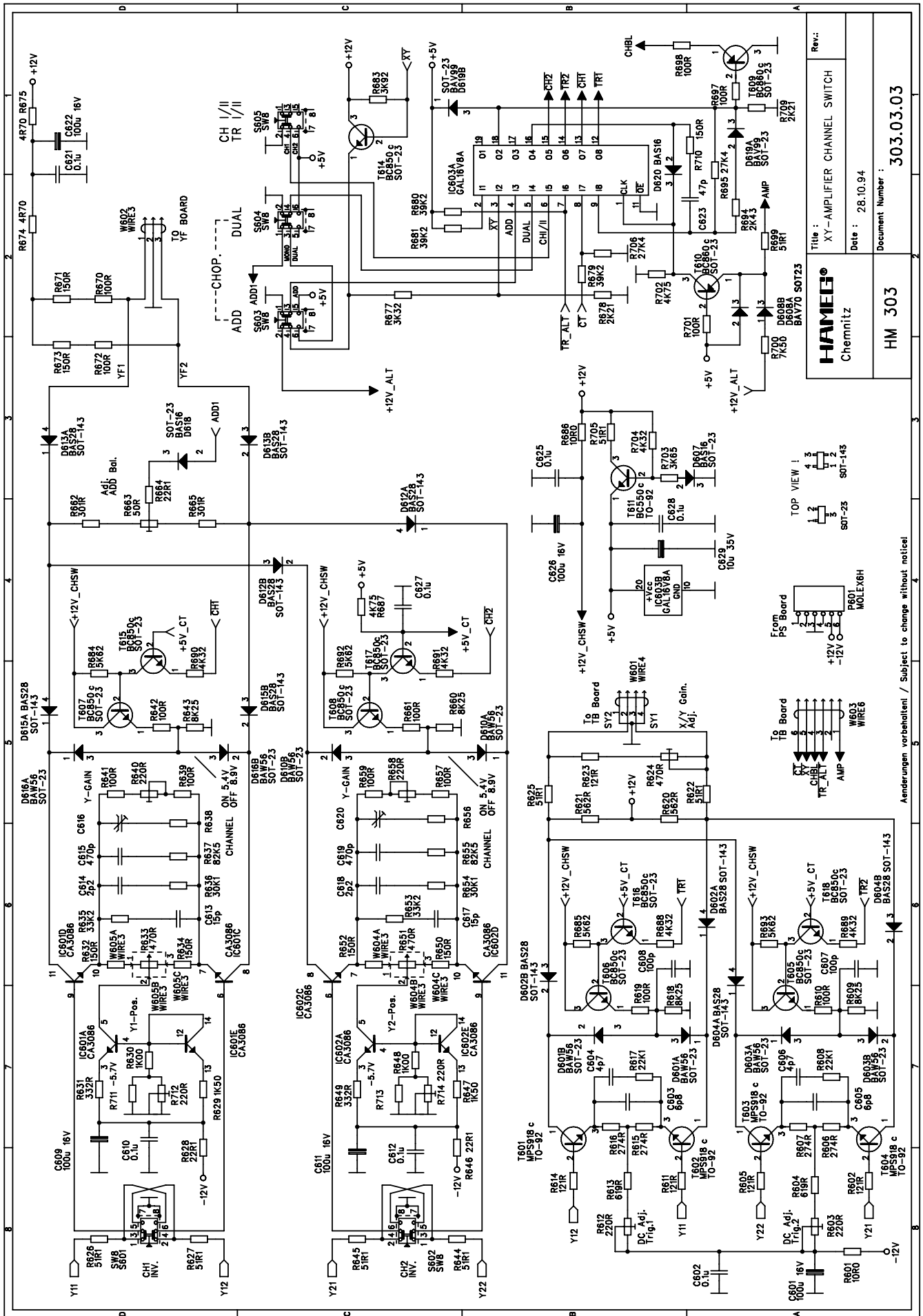

HAMEE®
Chemnitz

HM 303

Document Number : 303.03.03

Date : 28.10.94

Rev.: XY-AMPLIFIER CHANNEL SWITCH

Anderungen vorbehalten! / Subject to change without notice!

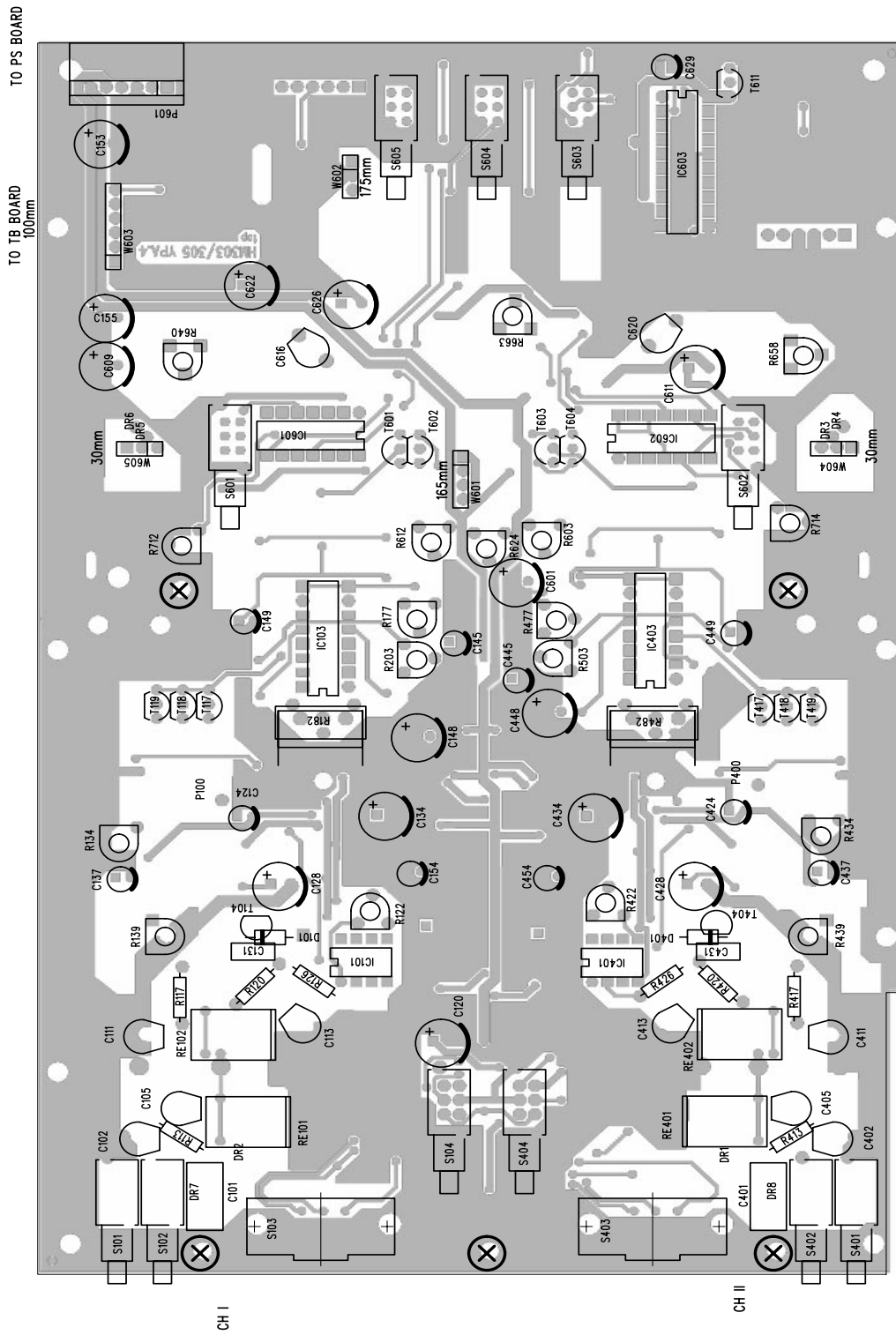

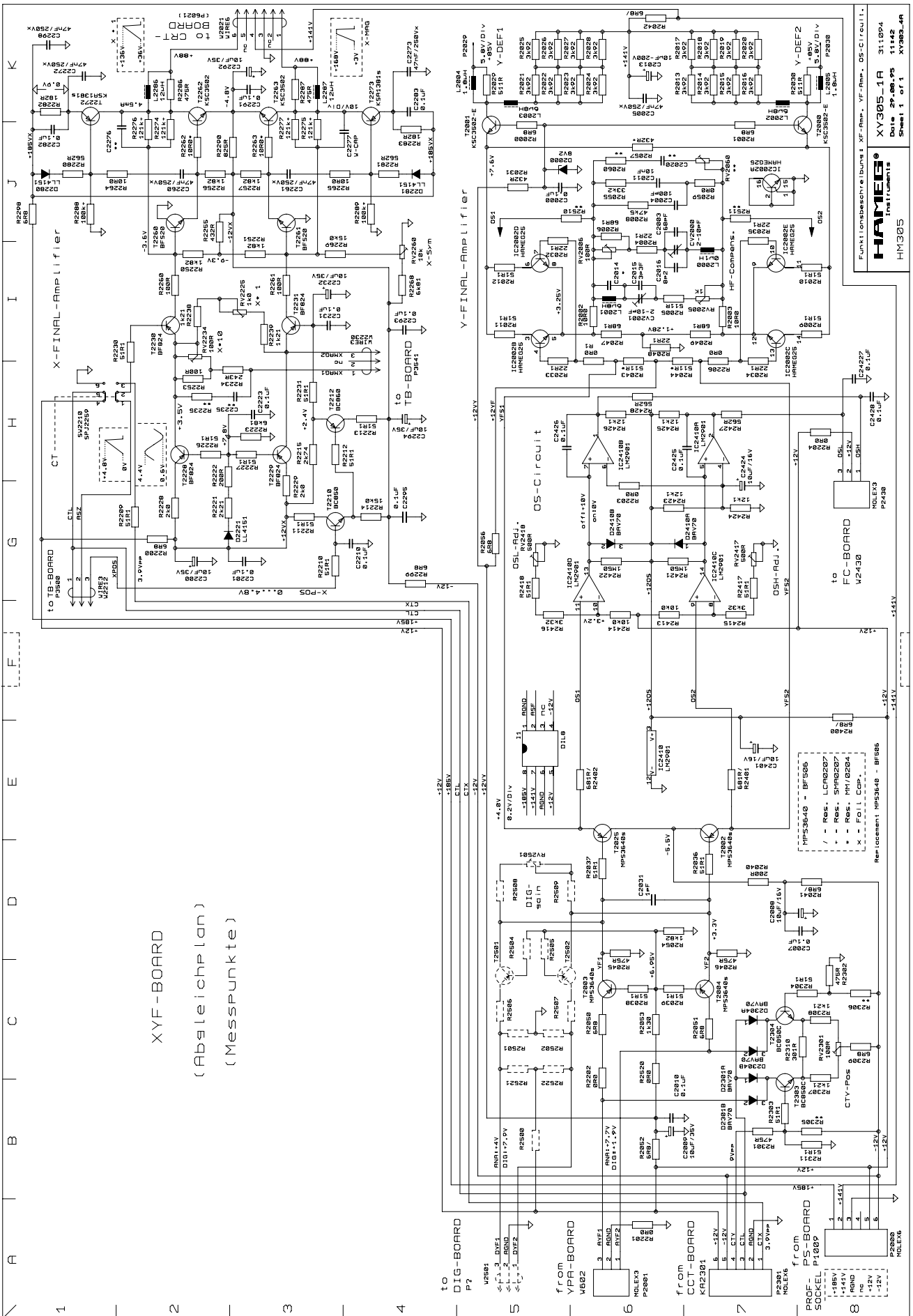

XY305-1A 31109-4
 Date 29.08.95 1142
 Sheet 1 of 1 XY305-4A
 HM305
 Funktionebeschreibungen XF-Ampl., YF-Ampl., OS-Circuit

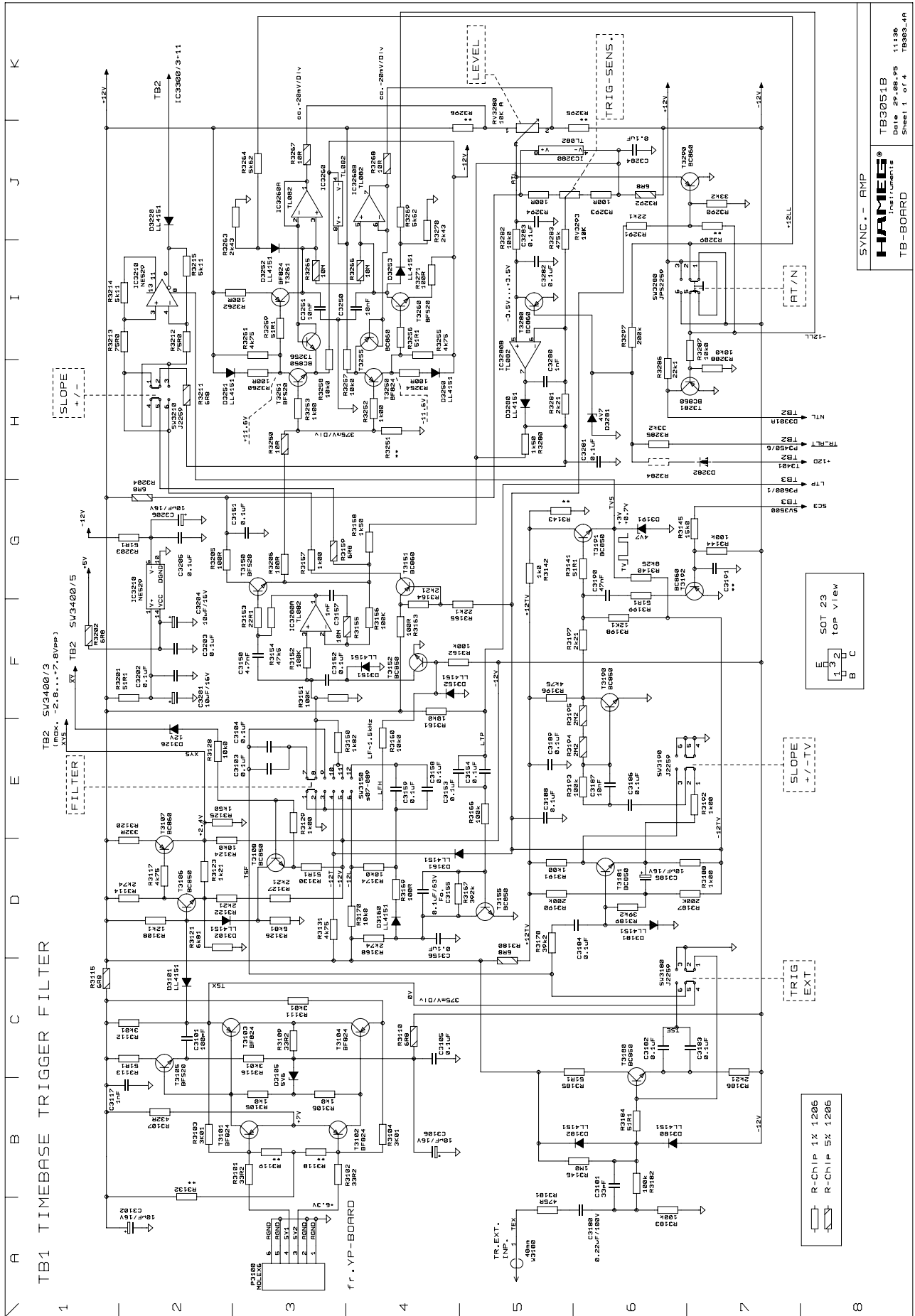

SYNCRAMP
HAMEL
 Instruments
TB3051B
 Date 29.08.95 11:30
 Sheet 1 of 4 TB303-4A

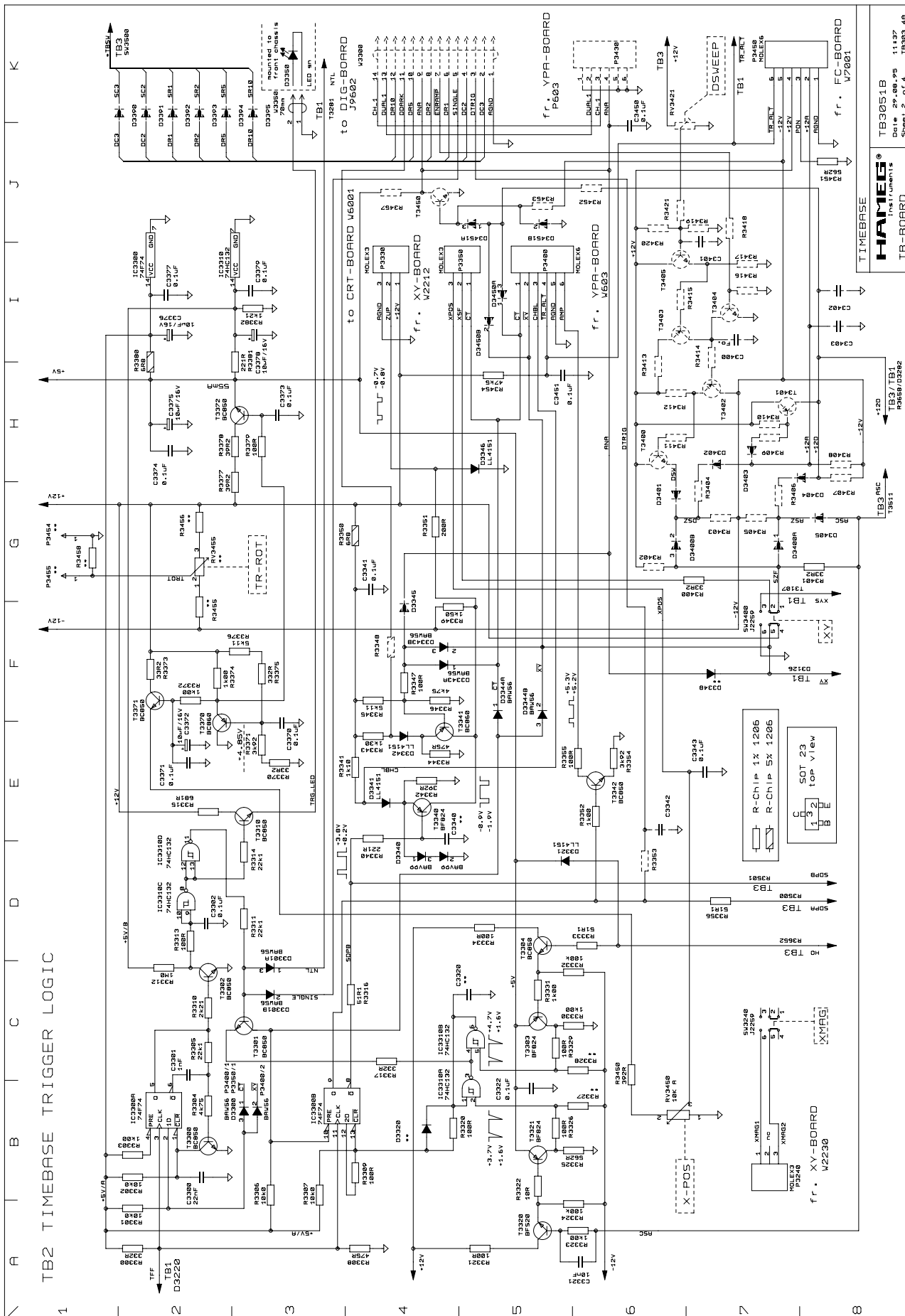

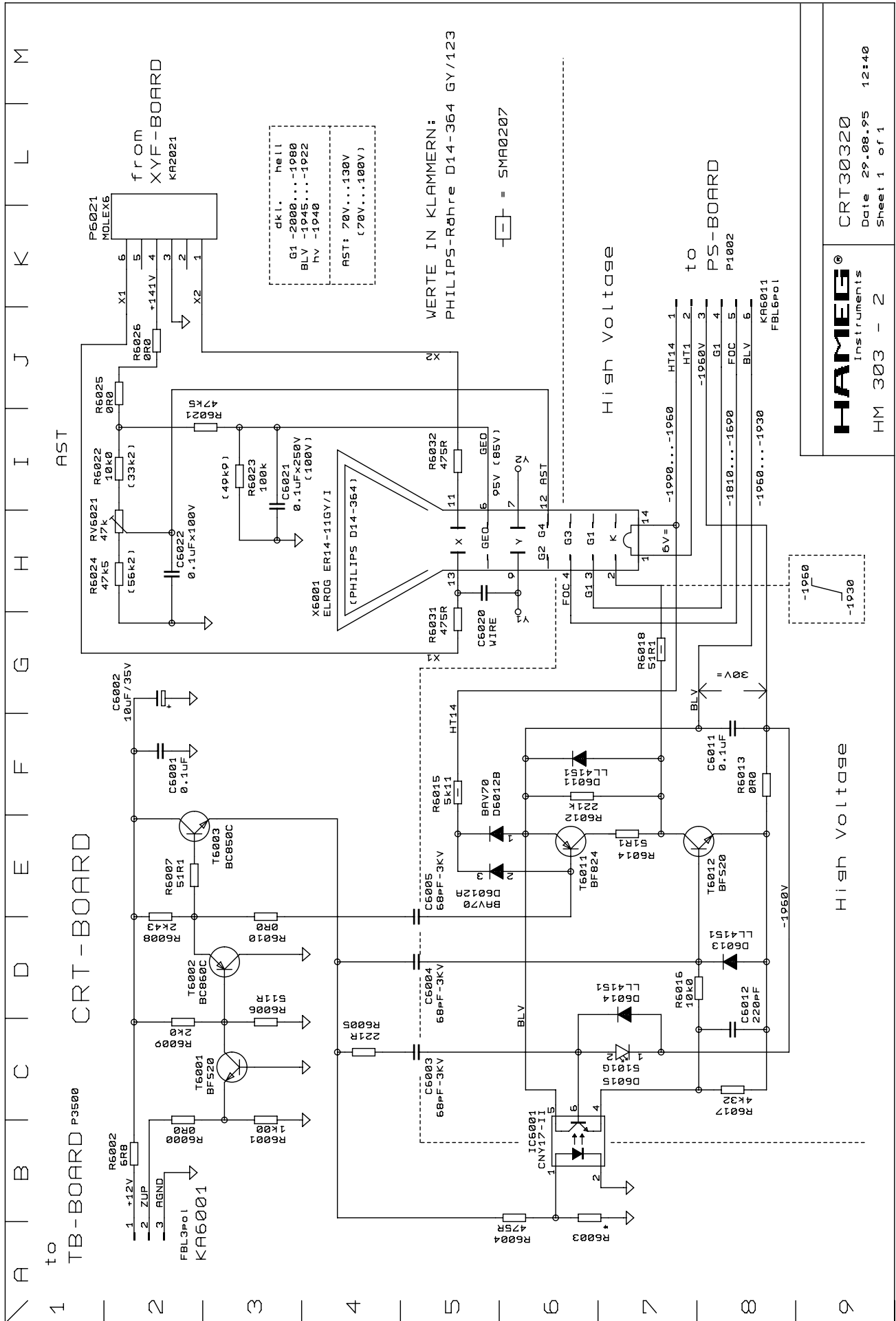

dkl. hell
G1 -2000...-1080
BLV -1045...-1922
HV -1040

AST: 70V...130V
(70V...100V)

WERTE IN KLAMMERN:
PHILIPS-Röhre D14-364 GY/123

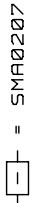

= SMA0207

CRT30320
Date 29.08.95 12:40
Sheet 1 of 1

HAMEG®
Instruments
HM 303 - 2

High Voltage

High Voltage

-1060
-1030

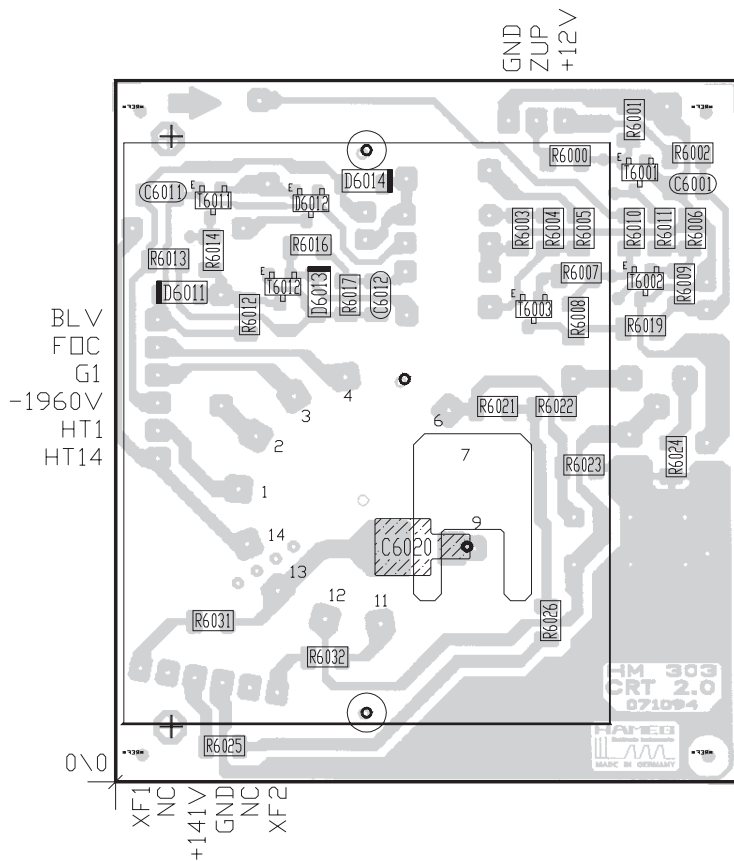
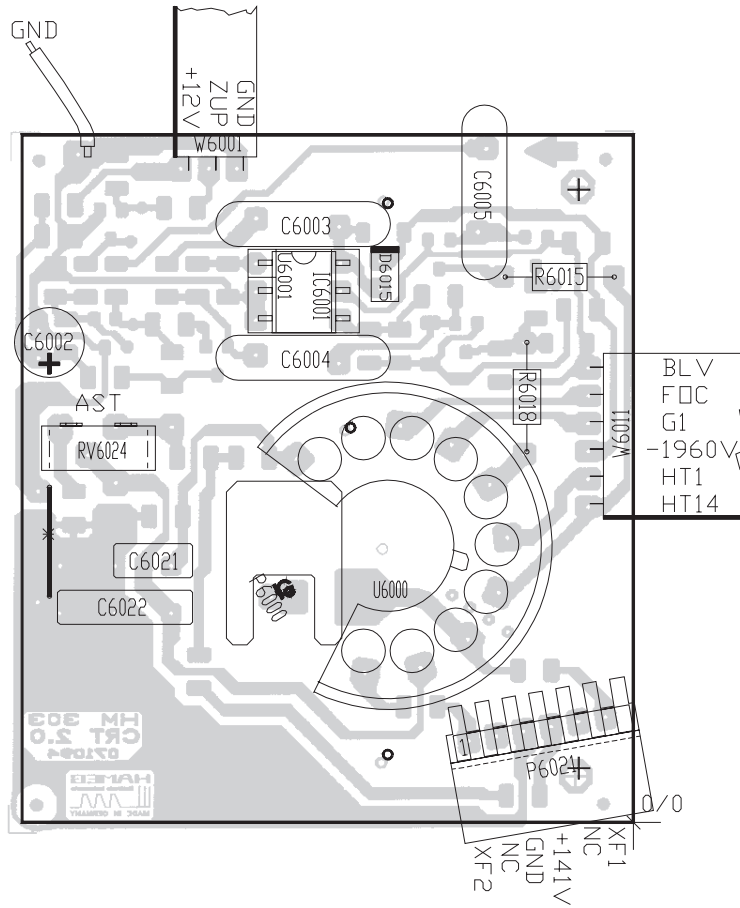

HM303

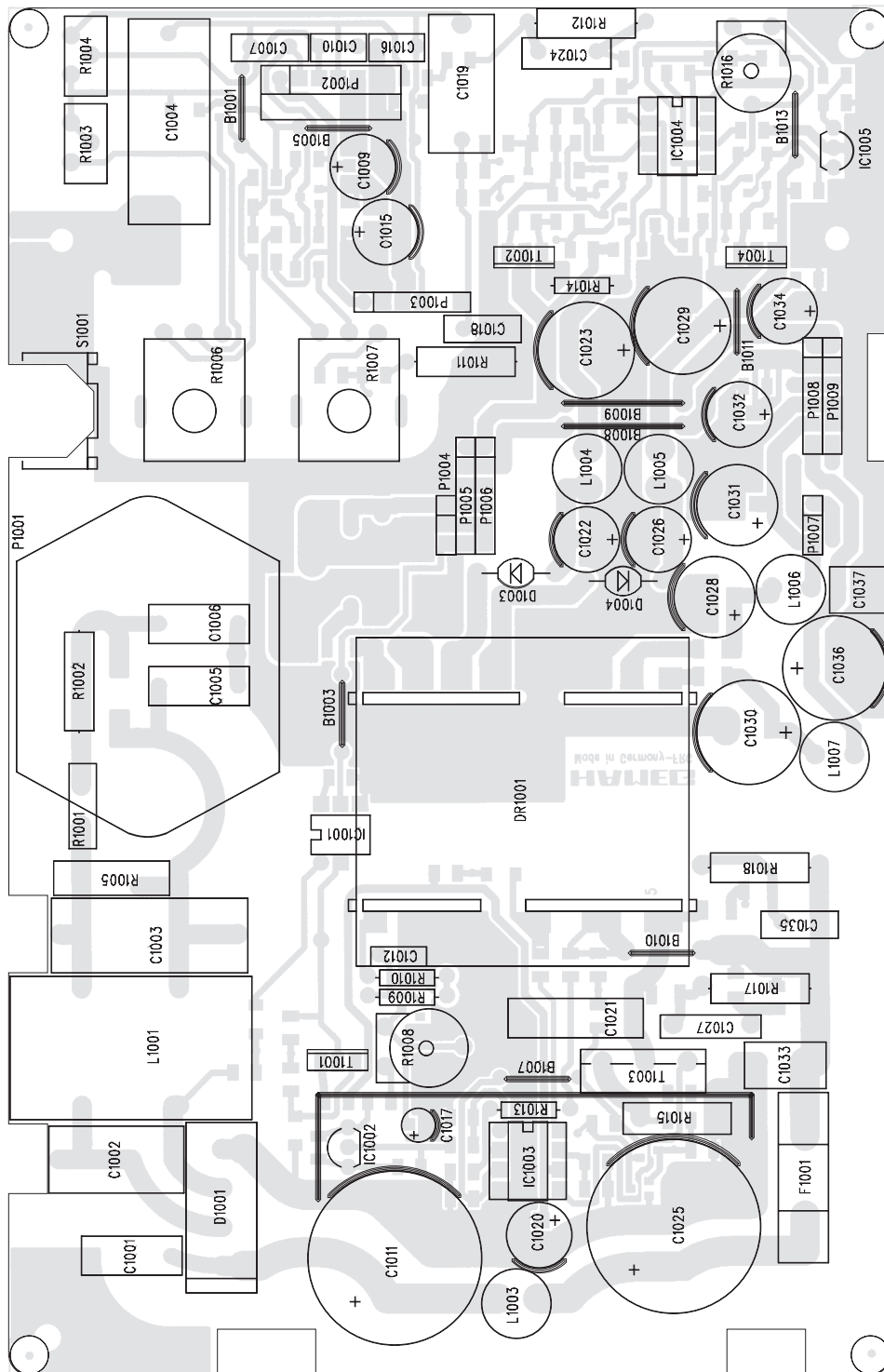

Besteckungsplan bedrante BE's

Bestückungsplan SMD BE's

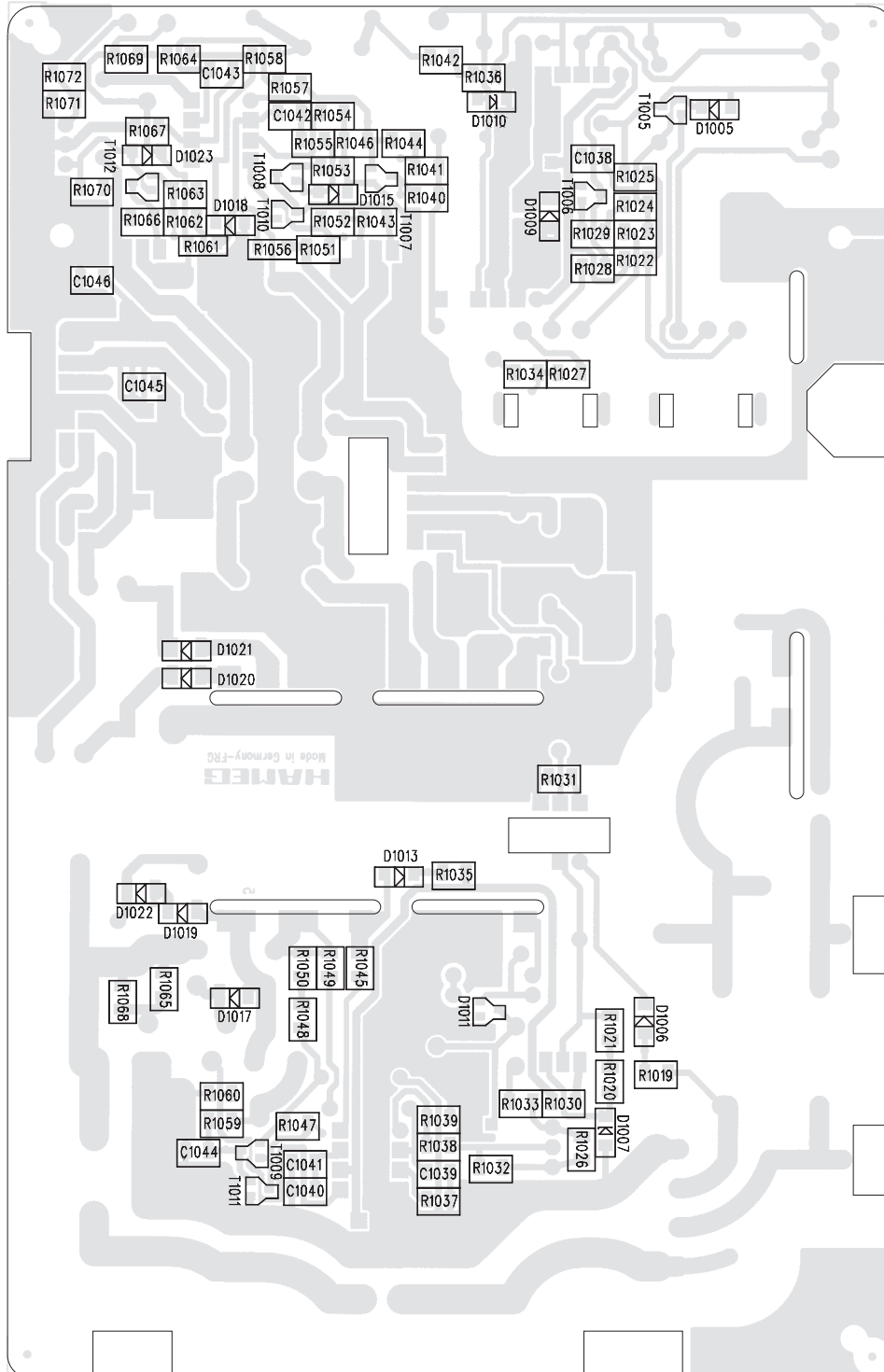

HM303

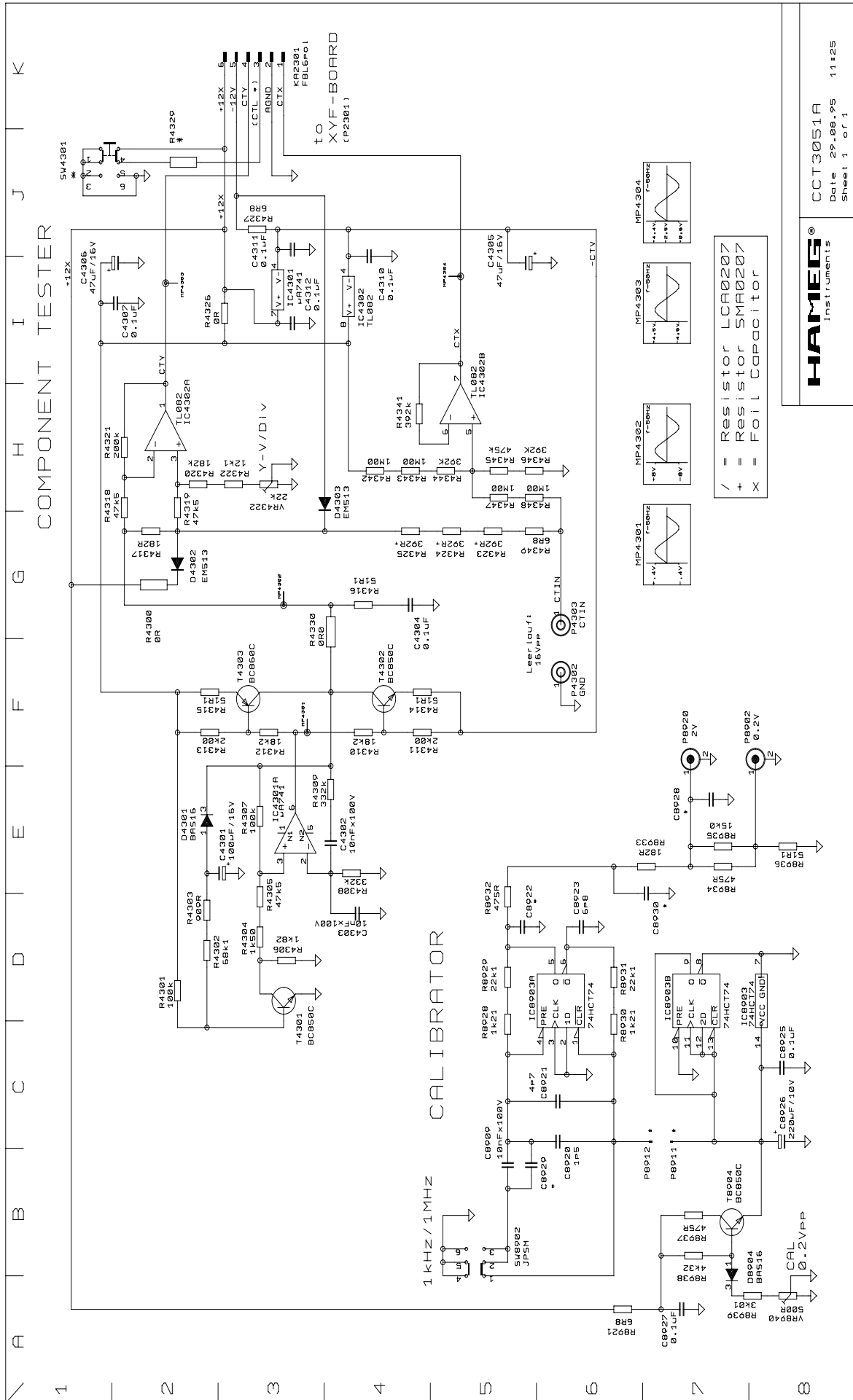

- ✓ = Resistor LCA0207
- + = Resistor SMA0207
- X = Foil Capacitor

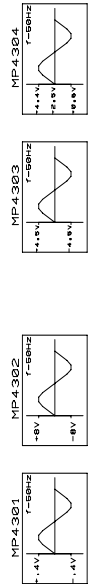

CCT3051A
Date 29.08.95 11:25
Sheet 1 of 1



CCT Board (Top and Bottom side)

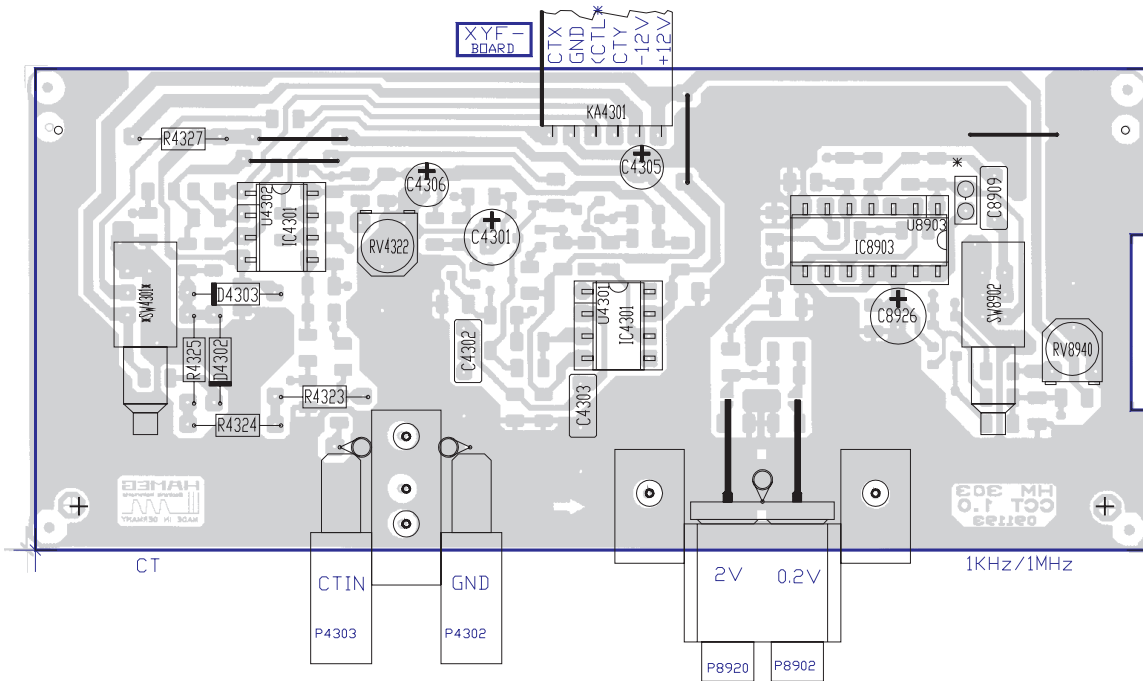
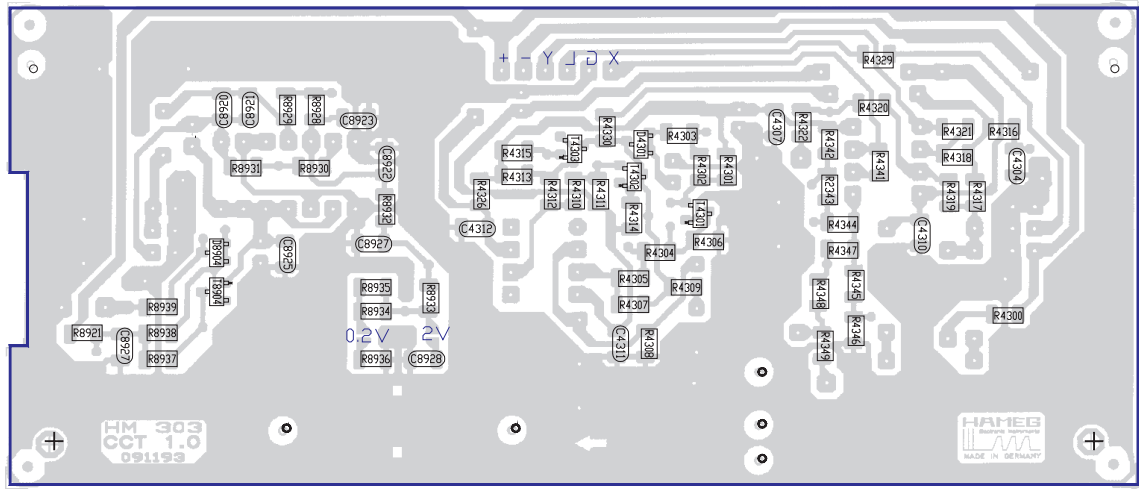

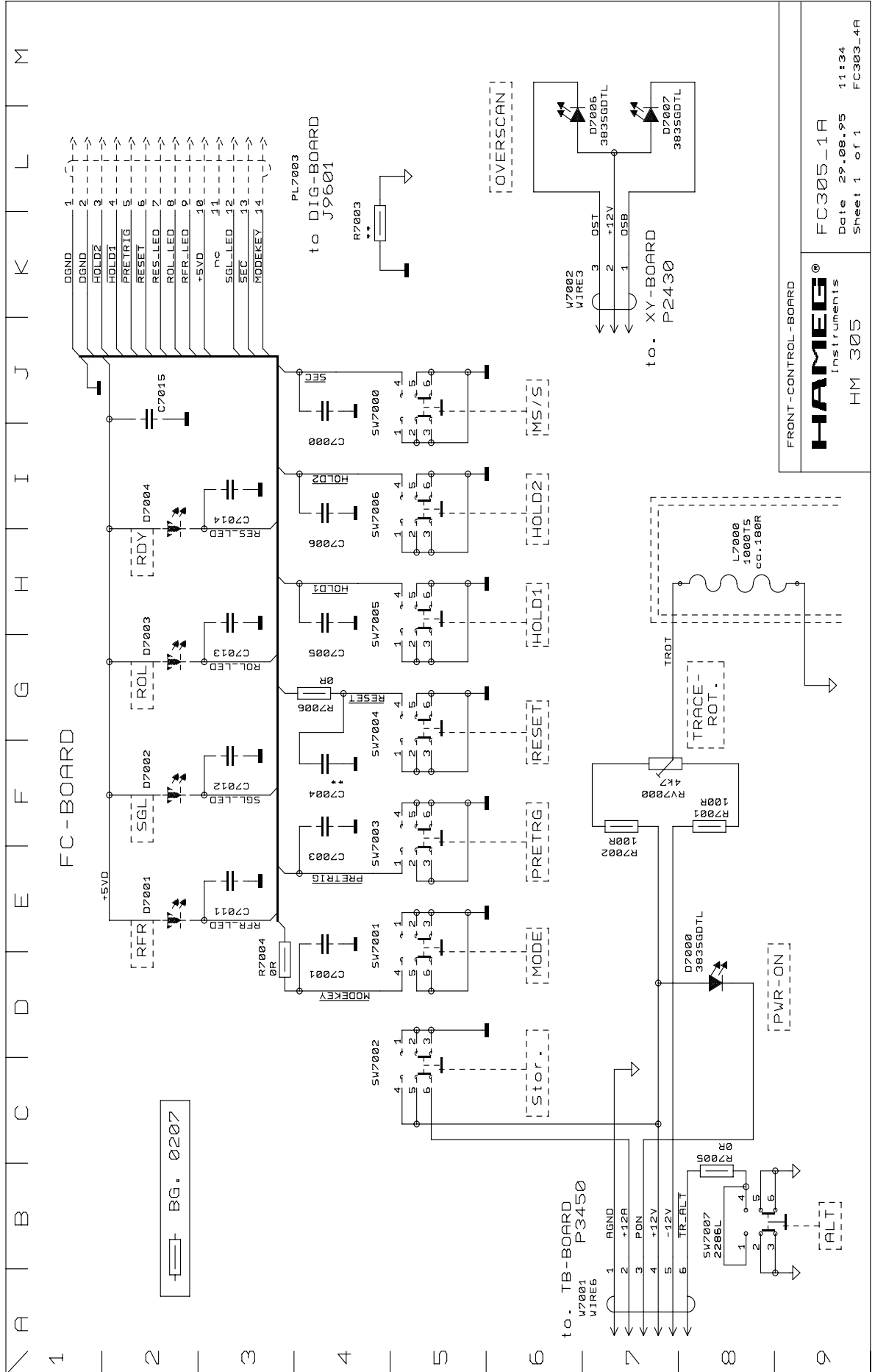

FRONT-CONTROL-BOARD

HAMEE[®]
Instruments

HM 305

FC305-1A
Date 29.08.95 11:34
Sheet 1 of 1 FC303-4A

Front Control board (Top and Bottomside)

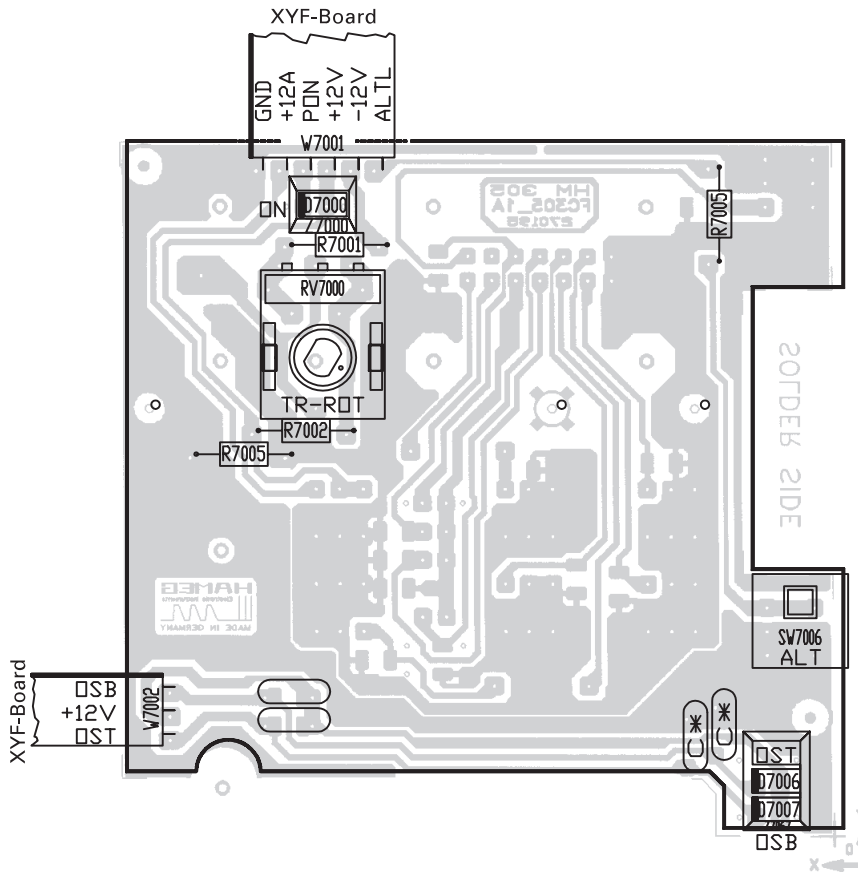

Adjustment Procedure

ADJUSTMENT PROCEDURE

30MHz Standard Oscilloscope HM303-4



WARNING

The Instrument must be disconnected from the mains power supply whenever you open the case, repair or exchange parts.

HIGH VOLTAGE WARNING!



Hazardous High Voltage of up to 2,000 Volts is present inside this Instrument. The areas particularly affected by High Voltage are the high voltage circuit on the PS-board, the CRT-board and the CRT-socket.

SERVICE AND ADJUSTMENT

- of this instrument should only be performed in accordance and in conjunction with the operating manual and the WARNINGS contained therein.
- should only be performed by suitable qualified and experienced service personnel, or should be referred to one of the HAMEG companies listed on the rear cover of the manual.

Test Instruments required:

- 1) Scope Tester HZ60-2.
- 2) Constant amplitude sinewave generator, 20Hz - 250MHz, output 5mV - 5V into 50 Ω , preferably with 20dB attenuation (e.g. HM8133, TEK SG502 + TEK SG503).
- 3) Amplitude Calibrator with 1kHz squarewave output and 600 Ω impedance, risetime faster than 150ns. Output voltage 2mV - 20Volts in 1-2-5 sequence for 4 divisions display amplitude (e.g. HZ62, TEK PG506).
- 4) Time mark generator from 5ns/div to 5s/div. Output min. 10mV into 50 Ω (e.g. HZ62, TEK TG501).
- 5) Pre-attenuator 2:1 (1M Ω , 12-48pF), e.g. HZ20.
- 6) 50 Ω BNC through termination, e.g. HZ22.
- 7) 2 BNC-cables, 50 Ω , e.g. HZ34.
- 8) BNC-T-connector.
- 9) Oscilloscope probe 10:1, with exactly 9M Ω series resistance and compensated for test oscilloscope mentioned under 10).
- 10) Oscilloscope 100MHz, 5mV/div to 5V/div, e.g. HM1005.
- 11) Trimming/adjusting tool.
- 12) Variable output safety insulation transformer.
- 13) Video signal generator with positive and negative signal output.
- 14) Yt-EPROM HM1007.

This procedure covers all adjustments and the most important - but not all - performance checks. The correct sequence of all adjustment steps must be strictly followed.

Exact adjustment is only possible when any influence of the earths' magnetic field has been compensated with the trimmer marked TR (trace rotation).

All adjustments should only be performed by qualified and experienced personnel. This is particularly important for adjustments in the high voltage section of the instrument.

(1)	R1008: +141 Volt supply.	29
(2)	R1016: +12 Volt supply.	29
(3)	VR7000: Trace Rotation Check.	29
(4)	R1004 : CRT minimum intensity.	29
(5)	R712RT maximum intensity.	29
(6)	R712: Mean Y-plate Potential Channel I.	29
(7)	R714: Mean Y-plate Potential Channel II.	29
(8)	RV6021 : Astigmatism correction.	31
(9)	R640: Y-Gain CH I.	31
(10)	R122: FET operating point CH I.	31
(11)	R203: Invert-Balance CH I.	31
(12)	R177: Variable-Balance CH I.	31
(13)	R139: 100Hz Squarewave 5mV/div CH I.	32
(14)	R134: 100Hz Squarewave 1mV/div Adjustment CH I.	33
(15)	R658: Y-Gain CH II.	33
(16)	R422: FET operating point CH II.	33
(17)	R503: Invert-Balance CH II.	33
(18)	R477: Variable-Balance CH II.	33
(19)	R439: 100Hz Squarewave 5mV/div CH II.	33
(20)	R434: 100Hz Squarewave 1mV/div CH II.	33
(21)	RV2005 (A), RV2006 (C), CV2000 (D) and CV2001 (B): Y-Final Amplifier. ...	35
(22)	Y-Amplifier Bandwidth Check.	35
(23)	C113/111/102/105: Attenuator Compensation CH I.	35
(24)	C413/411/402/405: Attenuator Compensation CH II.	35
(25)	R663: ADDition/Offset.	37
(26)	RV2417 (A), RV2418 (B): Overscan.	37
(27)	RV3519: Sweep start voltage.	37
(28)	RV2225: X-Magnification x1.	37
(29)	RV2260: X-Symmetry.	37
(30)	RV3591 (A)/3589 (C), CV3511 (B): Time base.	37
(31)	RV2234: X-Magnification x10.	39
(32)	R624: XY-Gain	39
(33)	RV3293: Trigger-Symmetry	39
(34)	R612: DC-Triggering CH I.	39
(35)	R603: DC-Triggering CH II.	39
(36)	RV2301 (A), 4322 (B): Component Tester Y-Position and Tilt.	41
(37)	VR8940: Calibrator Output.	41
(38)	Trigger Filter Check.	41
(39)	Triggerbandwidth Check.	41
(40)	External Trigger Check.	41
(41)	Video Trigger Check.	42

NOTE

The adjustment procedures assume that the instrument had once been properly adjusted in the factory and adjustments are required due to temperature drift or the replacement of defective components.

Before starting each adjustment procedure, set the oscilloscope to the following basic settings:

- Press POWER pushbutton (in!).
- Release all other pushbuttons (out!) except AC/DC input coupling.
- Rotate the three variable controls (TIME/DIV. and VOLTS/DIV.) to their (calibrated) detent positions.
- Set TIME/DIV. switch to 50 μ s/div.
- Set both VOLTS/DIV switches to 5mV/div.
- Rotate the HOLD OFF knob fully counterclockwise.
- Trigger coupling set to AC.
- Set all other controls to their midrange positions.

If different settings are required, they are mentioned particularly for each subject.

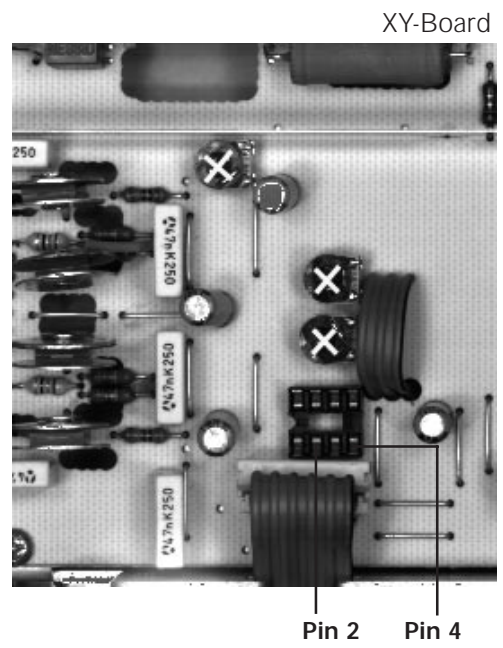
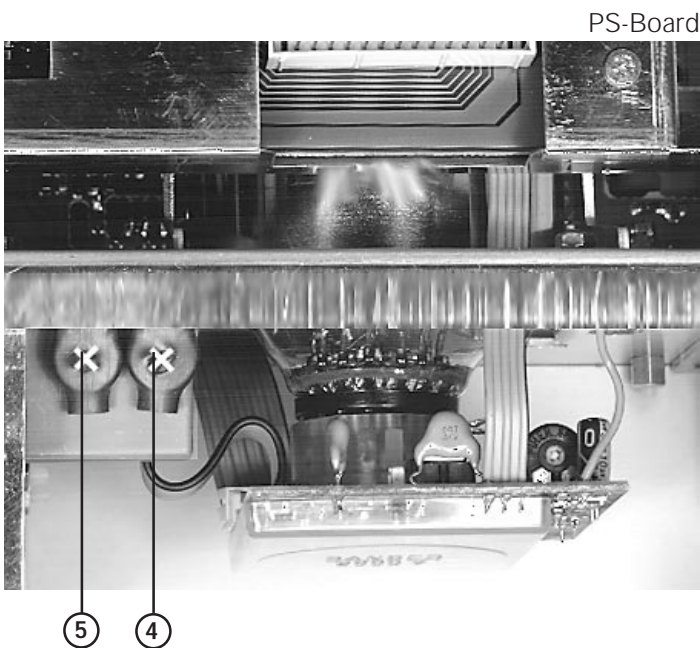
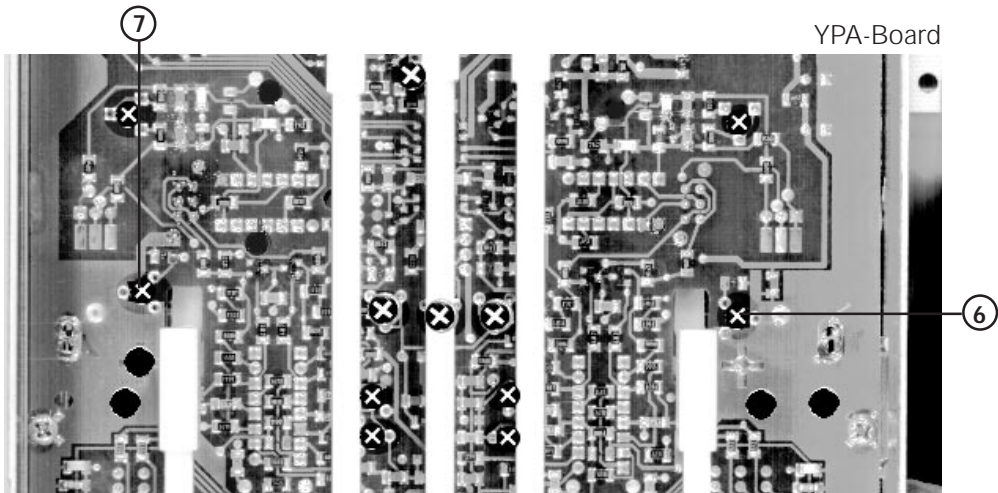
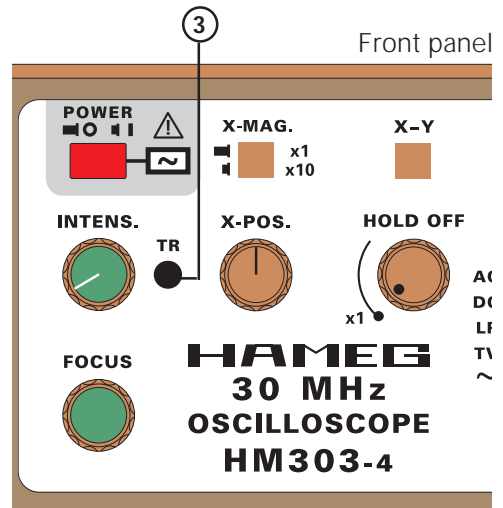
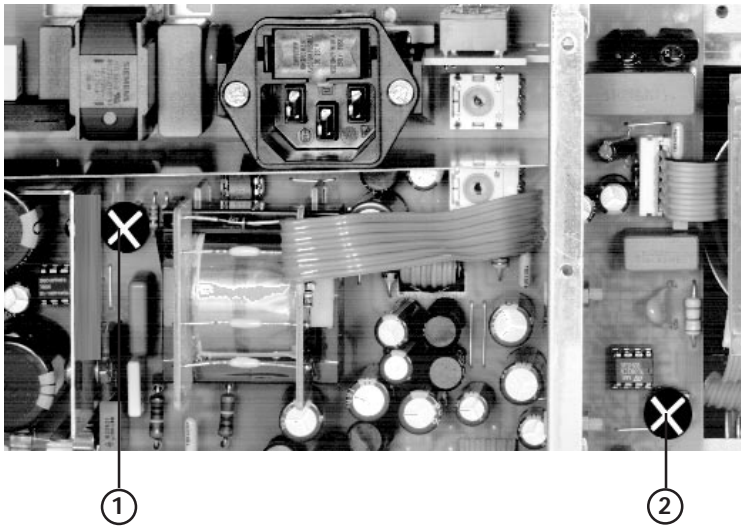

(1) **R1008: +141 Volt supply.**



WARNING: *To avoid damage use a fully insulated screwdriver!*
Locate and identify R1008 (1) on PS-Board (screened section).
Locate 8 pole checkpoint socket on XY-Board and identify pin 2.
Adjust R1008 (1) for exactly +141Volts (± 0.1 Volt).

(2) **R1016: +12 Volt supply.**

Locate and identify R1016 (2) on PS-Board.
Locate 8 pole checkpoint socket on XY-Board and identify pin 4.
Adjust R1016 (2) for exactly +12Volts (± 10 mV). All other voltages +185V (pin 1), -12V (pin 5) and -1950V on cathode of CRT depend on the correct +12 Volt adjustment. All these voltages must be checked and verified.

(3) **VR7000: Trace Rotation Check.**

Locate and identify VR703 (3) „TR“ on the front panel.
Using Y-Pos.I and X-Pos. controls, move baseline to the center of the graticule.
Press channel I GD pushbutton (in!).
When turning VR703 (3), check that the range of inclination of the baseline is at least 1mm at both horizontal limits of the graticule.
Readjust baseline exactly parallel to the horizontal center line of the graticule.

(4) **R1004 : CRT minimum intensity.**

Locate and identify R1004 (4) on PS-Board.
Set INTENS. control to fully left position.
Press XY pushbutton (in!).
Adjust R1004 (4) so that the dot just disappears.
Release XY pushbutton.

(5) **R1003 : CRT maximum intensity.**

Locate and identify R1003 (5) on PS-Board.
Set INTENS. control to fully right position.
Set FOCUS knob on the front panel for optimum sharpness.
Adjust R1004 (5) so that the beam diameter is 1.5mm.

Repeat adjustment 4 and 5 until optimum is obtained!

(6) **R712: Mean Y-plate Potential Channel I.**

Locate and identify R712 (6) on YPA-Board.
Press DUAL pushbutton (in!).
Set both beams to the horizontal center line of the graticule by using Y-position I and II knobs on the front panel. The Y-position knob settings must not be changed during the following procedure until item 7) is finished.
Release DUAL pushbutton (out!).
Switch the oscilloscope OFF.
Locate and identify both lines from the Y-final amplifier to the Y-plates of the CRT.
Connect both lines (short)galvanically.
Switch the oscilloscope ON.
Measure the DC voltage at the Y-plates in respect to ground.
Adjust R712 (6) for +85Volt Y-plate voltage.



Note: *Do not remove the short at the Y-plates until item 7) is finished.*

(7) **R714: Mean Y-plate Potential Channel II.**



Note: *Do not start item 7) until item 6) is finished.*
Locate and identify R714 (7) on YPA-Board.
Press CHI/II pushbutton (in!) for channel II mode.
Measure the DC voltage at the Y-plates in respect to ground.
Adjust R714 (7) for +85Volt Y-plate voltage.
Switch the oscilloscope OFF.
Remove the connection between both Y-plates.
Switch the oscilloscope ON.

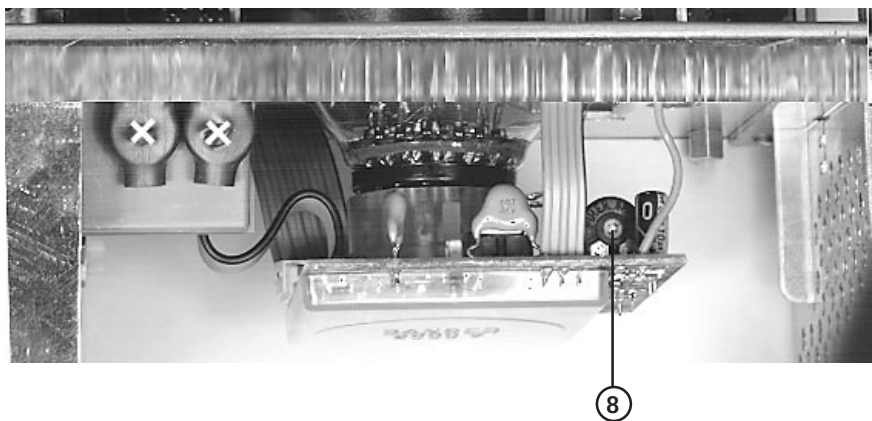
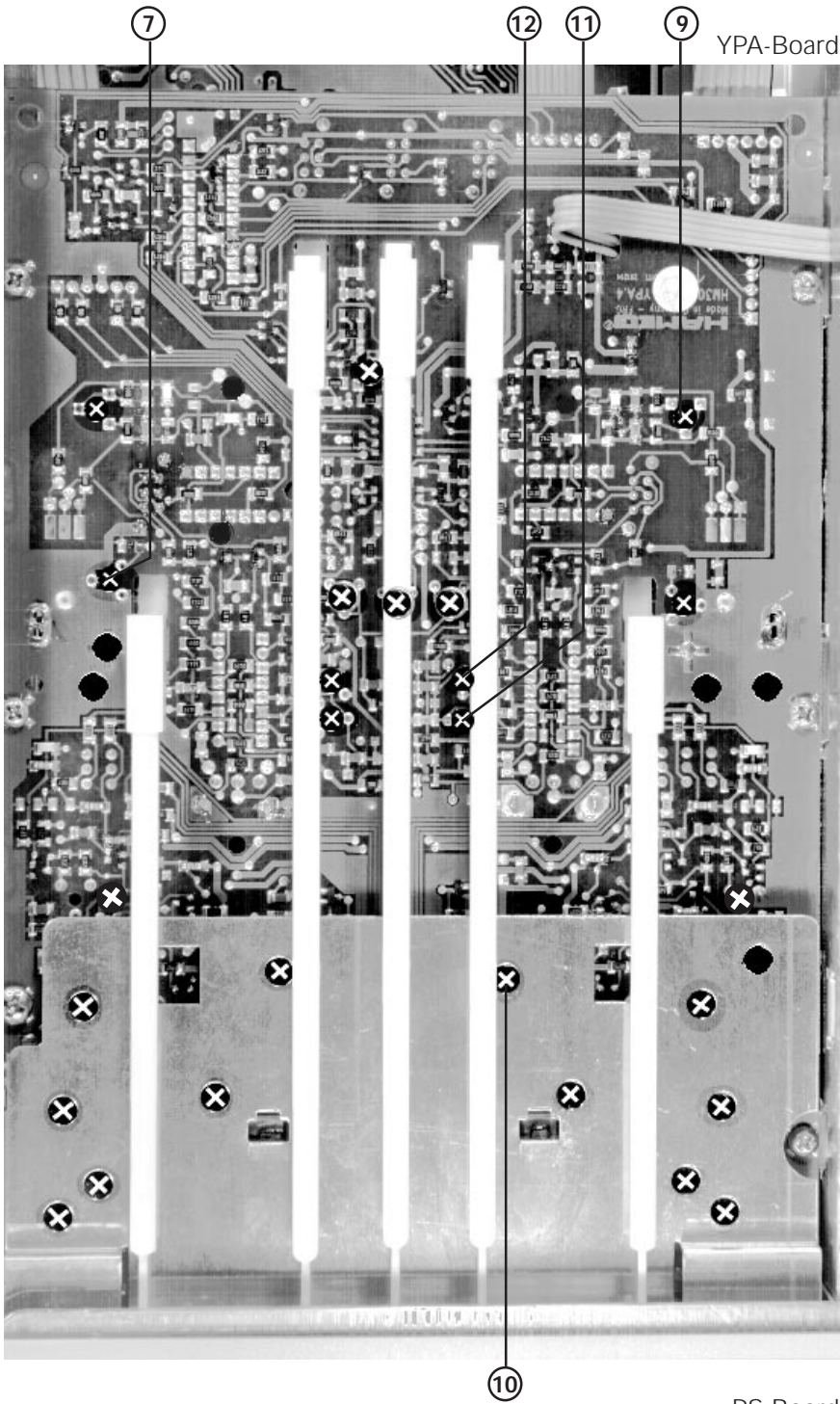

(8) RV6021 : Astigmatism correction.

Locate and identify RV6021 (8) on CRT-Board.
Connect a 1MHz squarewave signal with 25mVpp at 50Ω (HZ22) to input CHI.
Set time base to 0.1μs/div.
Adjust FOCUS control for optimum sharpness.
Adjust RV6021 (8) until leading edge and top of signal have equal sharpness.
Recheck range of FOCUS control.
Adjust FOCUS control for optimum sharpness.

(9) R640: Y-Gain CH I.

Locate and identify R640 (9) on YPA-Board.
Connect a 25mV/1kHz squarewave signal via 50Ω cable and 50Ω through terminator to input channel I.
Set time base to 1ms/div.
Adjust R640 (9) for 5 division signal height.

(10) R122: FET operating point CH I.

Locate and identify R122 (10) in CH I section of the YPA-Board.
Release all pushbuttons (out!) for channel I mode.
Press Y x5 channel I (in!) for 1mV/div.
Press GD pushbutton channel I (in!).
Switch the attenuator channel I constantly between 5mV/div (1mV) and 10mV/div (2mV).
Adjust R122 (10) until no Y-position change occurs.

Do not change the operating conditions.

(11) R203: Invert-Balance CH I.

Press GD pushbutton channel I (in!).
Press Y x5 channel I (in!) for 1mV/div.
Using Y-POS.I control set trace to the horizontal center line.
Locate and identify R203 (11) on YPA-Board.
Adjust R203 (11) so that the baseline will not move, when pressing and releasing the INVERT CH I pushbutton.

(12) R177: Variable-Balance CH I.

Locate and identify VR177 (12) in CH I section of the YPA-Board.
Press channel I Y-MAG. x5 pushbutton for 1mV/div.
Press channel I GD pushbutton (in!).
Adjust VR177 (12) so that the baseline will not move when turning the channel I Y-variable control through the entire range.

Check adjustment 11) again and repeat it if required.

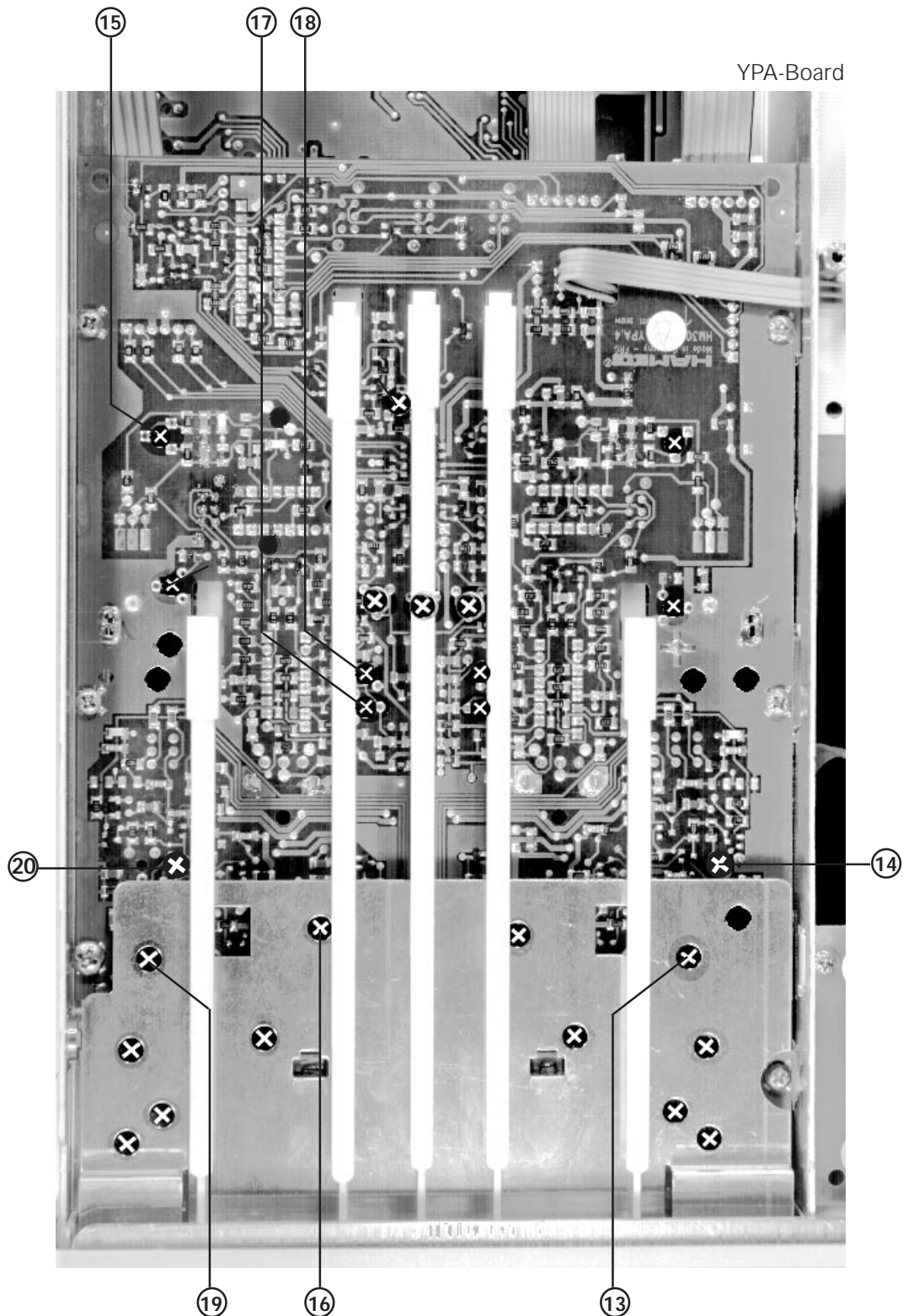

(13) R139: 100Hz Squarewave 5mV/div CH I.

Locate and identify R139 (13) in CH I section of the YPA-Board.
 Connect a 25mV/100Hz squarewave signal via 50Ω cable and 50Ω through terminator to input channel I.
 Set time base to 2ms/div.
 Check that DC input coupling is selected.
 Adjust R139 (13) for flat top.

(14) R134: 100Hz Squarewave 1mV/div Adjustment CH I.

Locate and identify R134 (14) in CH I section of the YPA-Board.
Connect a 5mV/100Hz squarewave signal via 50Ω cable and 50Ω through terminator to input channel I.
Press Yx5 channel I (in!) for 1mV/div.
Set time base to 2ms/div.
Check that DC input coupling is selected.
Adjust R134 (14) for flat top.

(15) R658: Y-Gain CH II.

Locate and identify R658 (15) on YPA-Board.
Connect a 25mV/1kHz squarewave signal via 50Ω cable and 50Ω through terminator to input channel II.
Check that DC input coupling is selected.
Set time base to 1ms/div.
Adjust R658 (15) for 5 division signal height.

(16) R422: FET operating point CH II.

Locate and identify R422 (16) in CH II section of the YPA-Board.
Press CHI/II pushbutton (in!) for channel II mode.
Press Y x5 channel II (in!) for 1mV/div.
Press GD pushbutton channel II (in!).
Switch the attenuator channel II constantly between 5mV/div (1mV) and 10mV/div (2mV).
Adjust R422 (16) until no Y-position change occurs.

(17) R503: Invert-Balance CH II.

Press GD pushbutton channel II (in!).
Press Y x5 channel II (in!) for 1mV/div.
Using Y-POS.II control set trace to the horizontal center line.
Locate and identify R503 (17) on YPA-Board.
Adjust R503 (17) so that the baseline will not move, when pressing and releasing the INVERT CH II pushbutton.

(18) R477: Variable-Balance CH II.

Locate and identify VR477 (18) in CH II section of the YPA-Board.
Press channel II Y-MAG. x5 pushbutton for 1mV/div.
Press channel II GD pushbutton (in!).
Adjust VR477 (18) so that the baseline will not move when turning the channel I Y-variable control through the entire range.

Check adjustment 17) again and repeat it if required.

(19) R439: 100Hz Squarewave 5mV/div CH II.

Locate and identify R439 (19) in CH II section of the YPA-Board.
Connect a 25mV/100Hz squarewave signal via 50Ω cable and 50Ω through terminator to input channel II.
Set time base to 2ms/div.
Check that DC input coupling is selected.
Adjust R439 (19) for flat top.

(20) R434: 100Hz Squarewave 1mV/div CH II.

Locate and identify R434 (20) in CH II section of the YPA-Board.
Connect a 5mV/100Hz squarewave signal via 50Ω cable and 50Ω through terminator to input channel II.
Press Yx5 channel II (in!) for 1mV/div.
Set time base to 2ms/div.
Check that DC input coupling is selected.
Adjust R434 (20) for flat top.

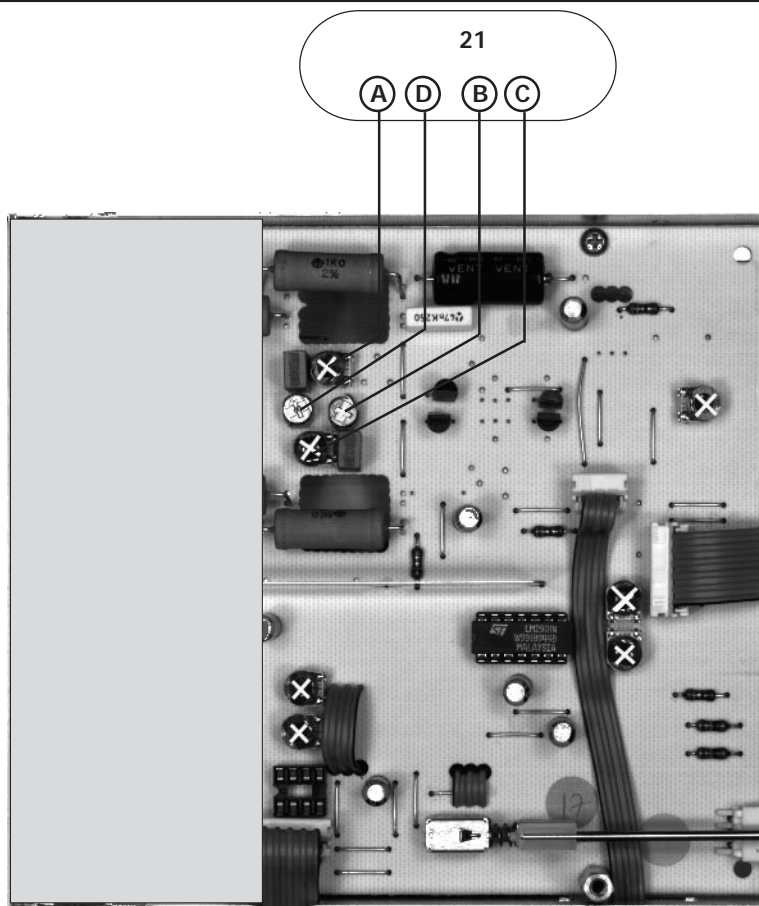

YPA-Board

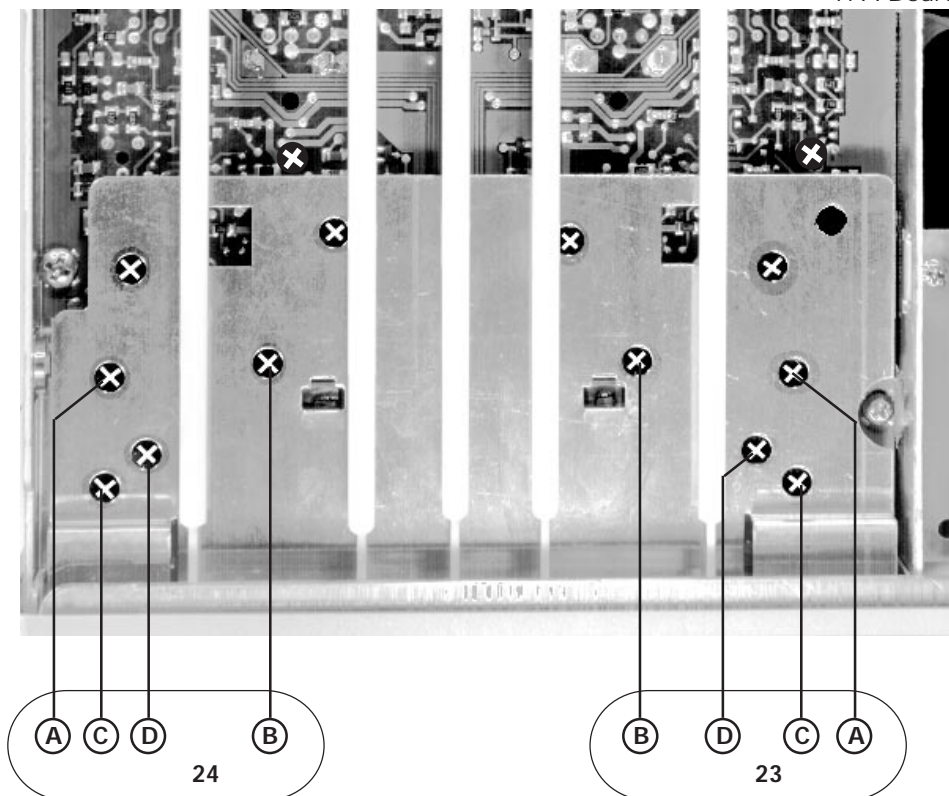

(21) RV2005 (A), RV2006 (C), CV2000 (D) and CV2001 (B):

Y-Final Amplifier.

Connect a 1MHz squarewave signal of 25mV via 50Ω cable and 50Ω through termination to input CH I.
Check that DC input coupling is selected.
Set time base to 0.2μs/div.
Locate and identify the adjustment points RV2005 (21A), RV2006 (21B), CV2000 (21C) and CV2001 (21D) on XY-Board.
As the capacitive influence of the cabinet is of importance, a metal sheet above the Y-final amplifier section is required.
Adjust RV2005 (21A) and CV2001 (21B) for flat top, RV2006 (21C) and CV2000 (21D) for fast leading edge with minimum overshoot.
Repeat until optimum is obtained.
Check channel II under the same conditions.

(22) Y-Amplifier Bandwidth Check.

Connect a 40mVpp/50kHz sinewave signal from a constant amplitude generator via a 50Ω through termination to the input of channel I.
Adjust the generator amplitude for 8 div. display height on the screen.
Increase the generator frequency until the signal is displayed with 5.6 div. height (-3dB).
Repeat the adjustment under item 21), if the frequency reading on the generator shows a value less than 30MHz.
Press CH I/II-TRIG I/II pushbutton (in!).
Connect a 40mVpp/50kHz sinewave signal from a constant amplitude generator via a 50Ω through termination to the input of channel II.
Adjust the generator amplitude for 8 div. signal height displayed on the screen.
Increase the generator frequency until the signal is displayed with 5.6 div. height (-3dB).
Repeat the adjustments under item 21), if the frequency reading on the generator shows a value less than 30MHz.

(23) C113/111/102/105: Attenuator Compensation CH I.

Locate and identify trimmers VC102-113 for CH I on YPA-Board.
Check that DC input coupling is selected.
Check that input attenuator CH I is in 5mV/div setting.
Set time base switch to 0.5ms/div.
Set amplitude calibrator to 1kHz and connect a 2:1 pre-attenuator via 50Ω cable to input of CH I.
Set calibrator output voltage to 80mVpp (40mVpp at the 2:1 pre-attenuator output, if terminated with 1MΩ).
Adjust trimmer in pre-attenuator for flat squarewave top. This adjustment must not be changed during the following procedure.
Adjust compensation as listed in the table below:

Scope Input	Input Atten.	Adjustment CH I
250mVpp 2.5Vpp	50mV/div 0.5V/div	A (VC111) flat top + B (VC113) leading edge C (VC102) flat top + D (VC105) leading edge

(24) C413/411/402/405: Attenuator Compensation CH II.

Locate and identify trimmers VC402-413 for CH II on YPA-Board.
Check that DC input coupling is selected.
Check that input attenuator CH II is in 5mV/div setting.
Set time base switch to 0.5ms/div.
Set amplitude calibrator to 1kHz and connect a 2:1 pre-attenuator via 50Ω cable to input of CH II.
Set calibrator output voltage to 80mVpp (40mVpp at the 2:1 pre-attenuator output, if terminated with 1MΩ).
Adjust trimmer in pre-attenuator for flat squarewave top. This adjustment must not be changed during the following procedure.
Adjust compensation as listed in the table below:

Scope Input	Input Atten.	Adjustment CH II
250mVpp 2.5Vpp	50mV/div 0.5V/div	A (VC411) flat top + B (VC413) leading edge C (VC402) flat top + D (VC405) leading edge

YPA-Board

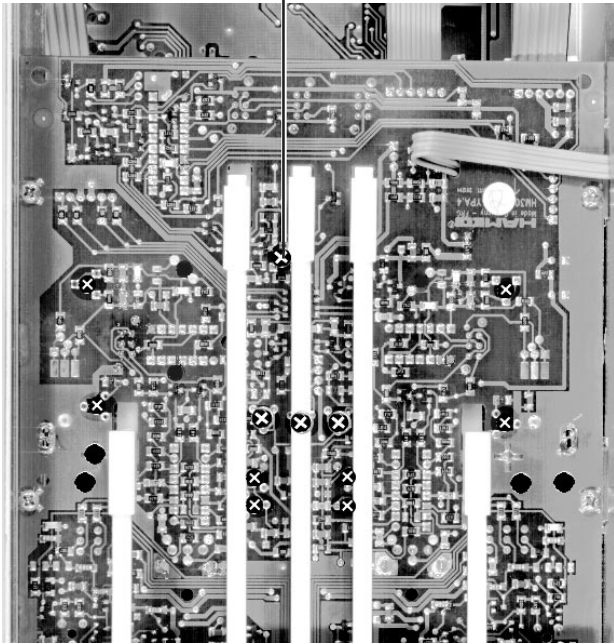

XY-Board

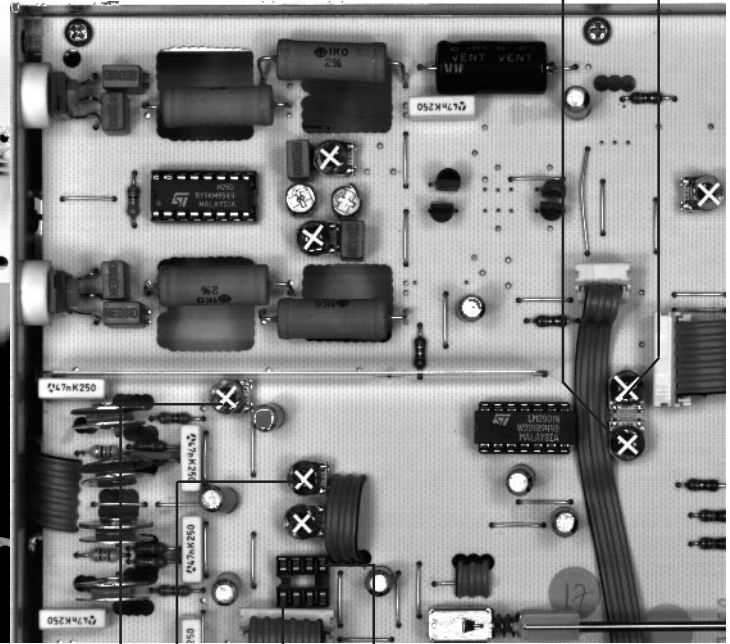

TB-Board

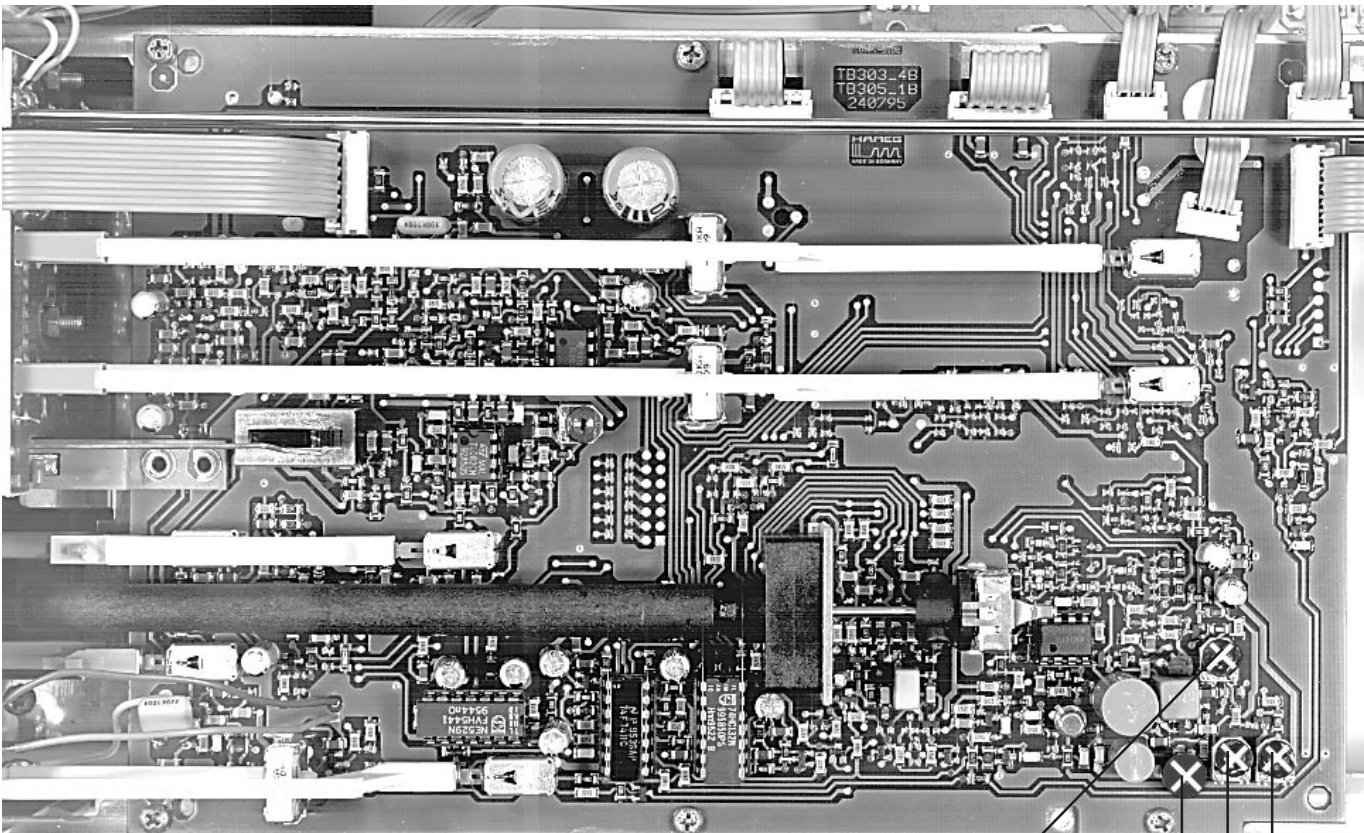

(25) R663: ADDition/Offset.

Press DUAL pushbutton (in!).
Locate and identify R663 (25) on YPA-Board.
Set input coupling CH I and II to GD.
Move both baselines with Y-POS. I and II controls to the horizontal center line of the graticule.
Release DUAL pushbutton (out!).
Press ADD pushbutton (in!).
Adjust R663 (25) for the same signal position as before in DUAL mode.

(26) RV2417 (A), RV2418 (B): Overscan.

Locate and identify RV2417 (26A) and RV2418 (26B) on XY-Board.
Press channel I and channel II GD pushbuttons (in!).
Press DUAL pushbutton (in!).
Set baseline with Y-POS.I control to the top line of the graticule.
Set baseline with Y-POS.II control to the bottom line of the graticule.
Adjust RV2417 (26A) for just lighting up of the upper LED.
Adjust RV2418 (26B) for just lighting up of the lower LED.
Repeat both procedures until both adjustments are correct.

(27) RV3519: Sweep start voltage.

Locate and identify RV3519 (27) on TB-Board.
Set time base to .2ms/div.
Locate and identify pin 7 of test socket on XY-Board.
Use a control oscilloscope with a x10 (10:1) probe and measure under DC input coupling conditions the sawtooth voltage at pin 7.
Adjust RV3519 (27) for 0 volts DC at the sawtooth start (end of the hold off time).

(28) RV2225: X-Magnification x1.

Locate and identify RV2225 (28) on XY-Board.
Set time base to .2ms/div.
Adjust RV2225 (28) for 10.2 div sweep length.

(29) RV2260: X-Symmetry.

Locate and identify RV2260 (29) on XY-Board.
Set the X-POS. knob to the mechanical center position.
Adjust RV2260 (29) for a symmetrical trace position in respect to the graticule.

(30) RV3591 (A)/3589 (C), CV3511 (B): Time base.

- a) Locate and identify RV3591 (A) on TB-Board.
Set time mark generator to $f = 20\text{kHz}$ and connect signal to CH I input.
Set time base to $50\mu\text{s/div}$.
Move trace with X-Pos. control so that the first time mark coincides with the first left graticule line of the screen.
Adjust RV3591 (30A) so that the 11th time mark coincides with the last right graticule line.
Rotate time base variable control to fully left position.
Now more than 2.5 time marks per division should be displayed.
- b) Locate and identify CV3511 (30B) on TB-Board.
Set time base to $0.5\mu\text{s/div}$. and time base variable control to CAL position.
Set time mark generator to $f = 2\text{MHz}$.
Move trace with X-POS. control so that the first time mark coincides with the first left graticule line of the screen.
Adjust CV3511 (30B) so that the 11th time mark coincides with the last right graticule line.
- c) Locate and identify RV3589 (30C) on TB-Board.
Set time base to 5ms/div . and time base variable control to CAL position.
Set time mark generator to $f = 200\text{Hz}$.
Move trace with X-POS. control so that the first time mark coincides with the first left graticule line of the screen.
Adjust RV3589 (30C) so that the 11th time mark coincides with the last right graticule line.

Check all time base settings with suitable time mark signals.

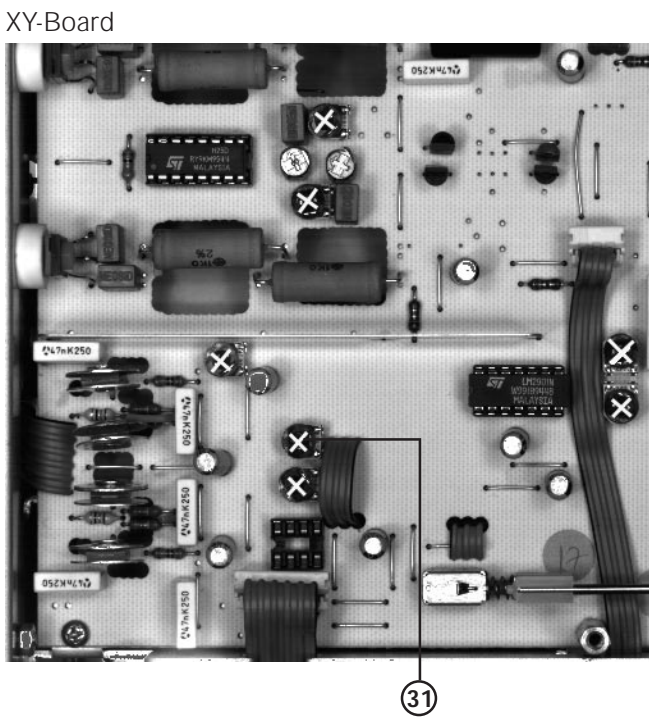
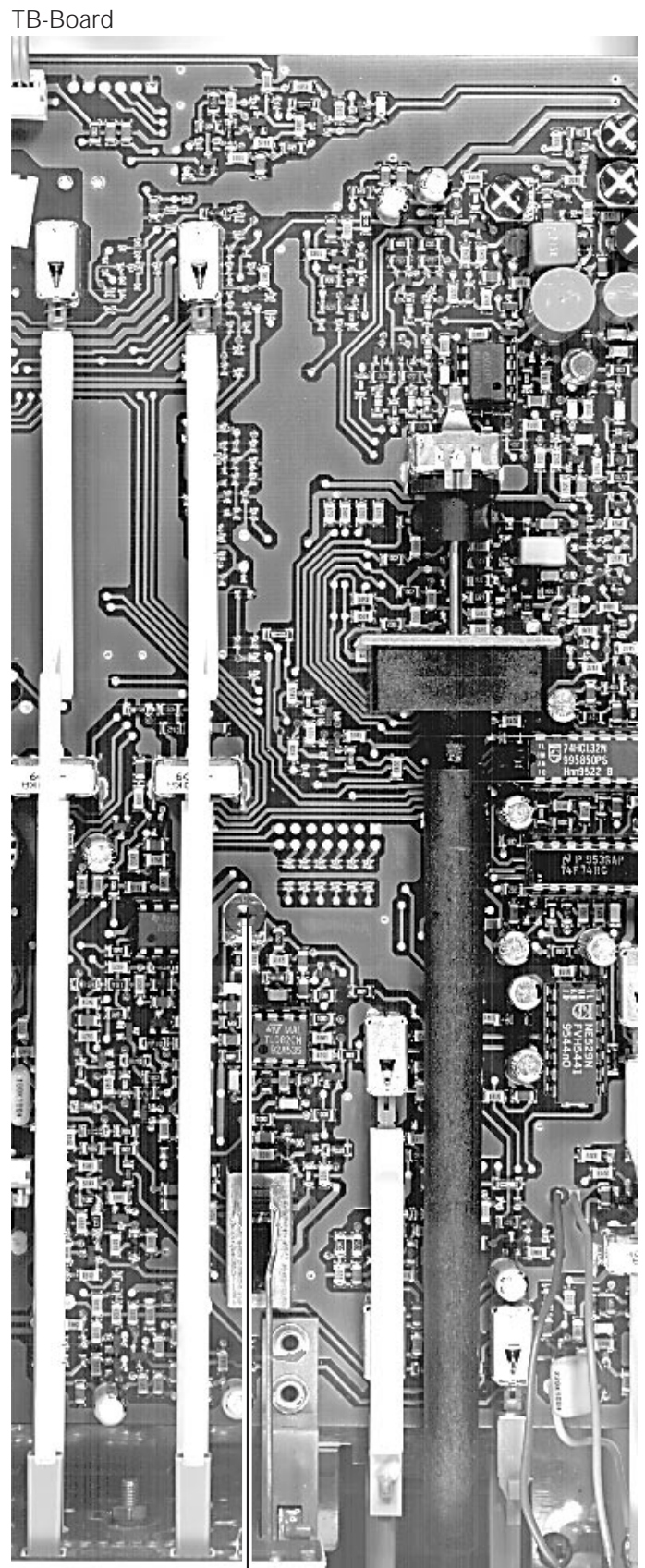
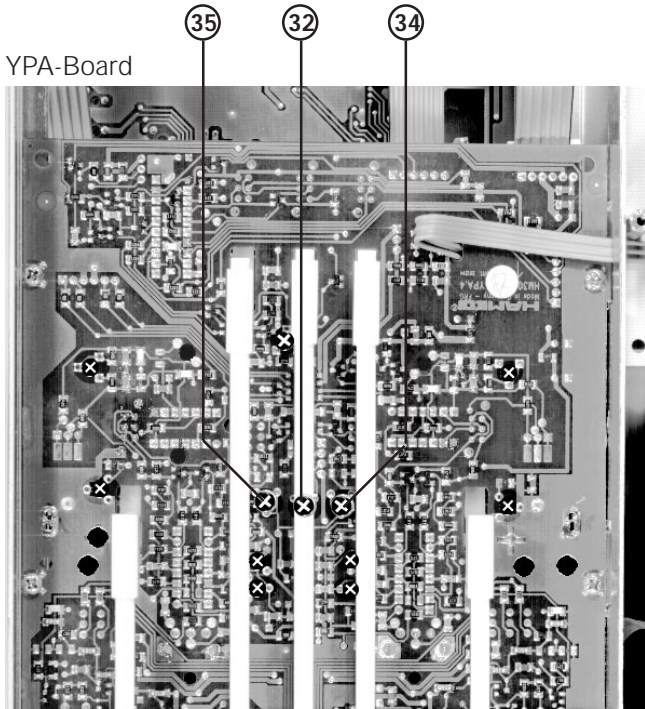

(31) RV2234: X-Magnification x10.

Locate and identify RV2234 (31) on XY-Board.
Press pushbutton X-Mag. x10.
Set time base to 50 μ s/div.
Set time mark generator to f= 20kHz and connect signal to CH I input.
Set X-POS control to mechanical center.
Using X-POS control, move the visible time mark to the first left graticule line.
Adjust RV2234 (31) so that the next time mark coincides with the last (right) graticule line.
Release X-MAG. x10 pushbutton (out!).

(32) R624: XY-Gain

Connect a 1kHz squarewave signal of 25mVpp amplitude (HZ60-2) to input CH II.
Check that the CH II input sensitivity is 5mV/div.
Check that DC input coupling is selected.
Locate and identify R624 (32) on YPA-Board.
Press XY pushbutton.
Set X-POS control that the left dot coincides with the graticule center.
Adjust R624 (32) for a distance of 5 division between left and right dot.

(33) RV3293: Trigger-Symmetry

Locate and identify RV3293 (33) on TB-Board.
Connect a 50kHz sinewave signal of 40mVpp amplitude to input CH I.
Set input coupling CH I to AC.
Check that trigger coupling is in AC position.
Set attenuator switch CH I to 0.1V/div (calibrated position).
Press AT/NORM. pushbutton (in!).
Turn LEVEL control for triggering (center position).
Reduce signal height and correct LEVEL setting for just triggering with a minimum signal height.
Press and release the trigger SLOPE \pm pushbutton and adjust RV3293 (33) for stable triggering in both SLOPE conditions.

(34) R612: DC-Triggering CH I.

Locate and identify R612 (34) on YPA-Board.
Connect a 50kHz sinwave signal to input CH I.
Set generator amplitude to 8cm.
Set time base to 10 μ s/div.
Press AT/NORM. pushbutton (in!).
Turn LEVEL control to the center position.
Release AC/DC input coupling pushbutton CH I (out!).
Constantly switch between AC and DC trigger coupling and watch the trace start position.
Adjust R612 (34) so that there is no difference regarding the signal start position on the signal slope between DC and AC trigger coupling.

(35) R603: DC-Triggering CH II.

Locate and identify R603 (35) on YPA-Board.
Connect a 50kHz sinwave signal to input CH II.
Press CH I/II-TRIG I/II pushbutton (in!).
Set generator amplitude to 8cm.
Set time base to 10 μ s/div.
Press AT/NORM. pushbutton (in!).
Turn LEVEL control to the center position.
Release AC/DC input coupling pushbutton CH II (out!).
Constantly switch between AC and DC trigger coupling and watch the trace start position.
Adjust R603 (35) so that there is no difference regarding the signal start position on the signal slope between DC and AC trigger coupling.

XY-Board

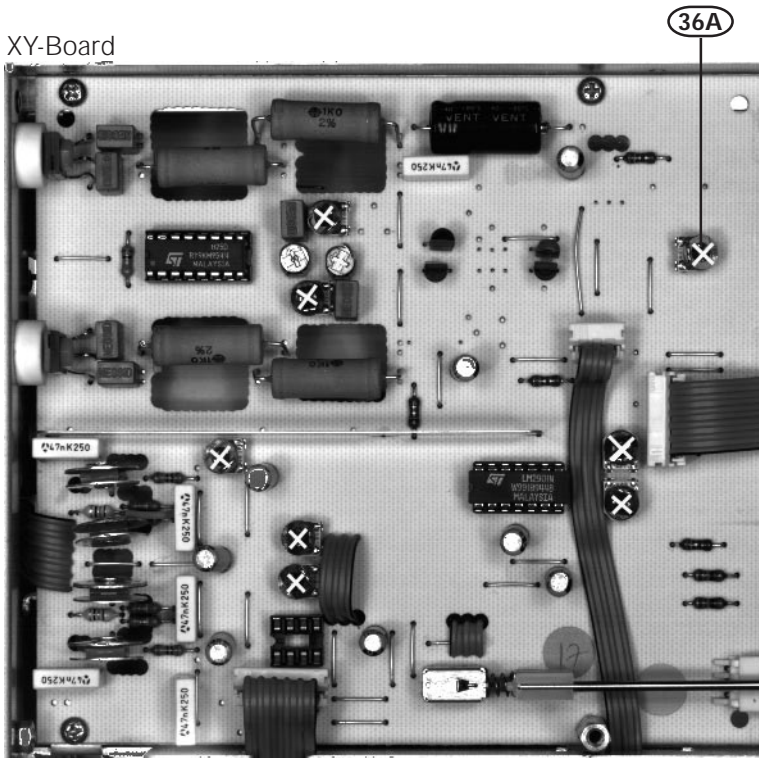

CT-Board

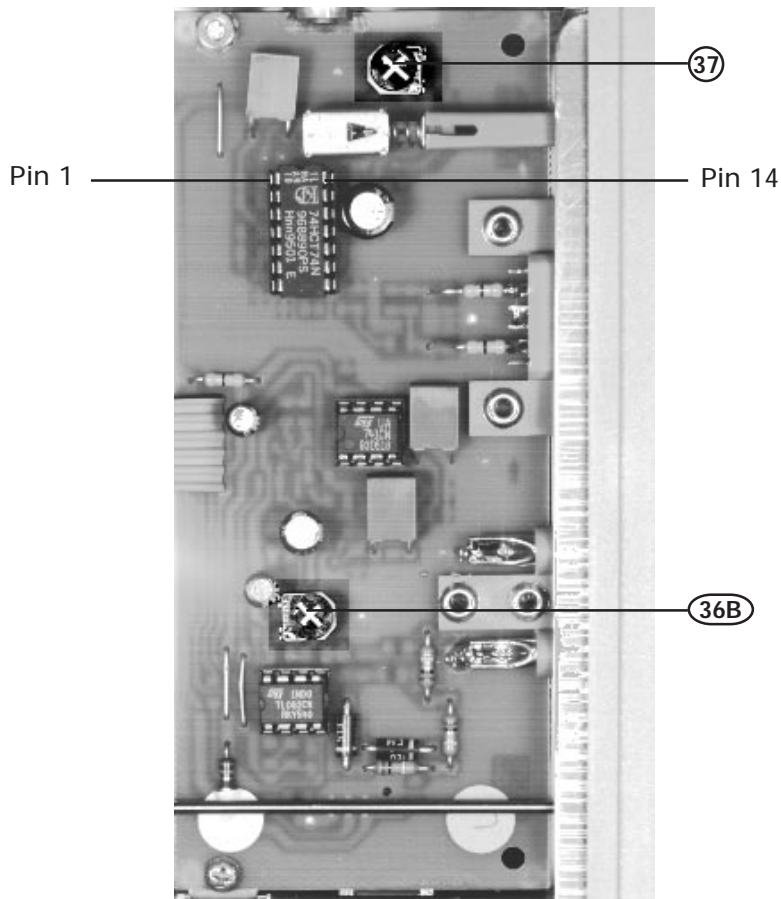

(36) RV2301 (A), 4322 (B): Component Tester Y-Position and Tilt.

Release all pushbuttons (out!).
Press COMPONENT TESTER pushbutton (in!).
Locate and identify RV2301 (36A) on XY-Board.
Adjust RV2301 (36A) to shift the approx. 8 div. horizontal component tester trace to the horizontal center of the CRT graticule.
Locate and identify RV4322 (36B) on CC-Board.
Set up the instrument on a table in normal operating conditions to avoid misadjustment due to the influence of the earth magnetic field.
Adjust RV4322 (36B) in such a way that the trace is parallel to the horizontal graticule center line and not tilt. This adjustment

(37) VR8940: Calibrator Output.

Locate and identify VR8940 (37) on CC-Board.
Connect a digital multimeter to the 0.2Vpp calibrator output.
Set up the digital multimeter for DC measurement in a suited sensitivity setting.
Locate and identify IC8903 on CC-Board.
Connect pin 1 and pin 14 of IC8903 galvanically together.
Adjust VR8940 (37) for exactly 0.2V DC.
Check 2V calibrator output.
Remove the connection between pin 1 and pin 14 of IC8903.

Connect a 10:1 probe to the 0.2Vpp calibrator output and connect it to the CH I input of the scope.
Release all pushbuttons (out!).
Select CH I DC input coupling.
Set attenuator CH I to 5mV/div (calibrated detent).
Set time base to 0.2ms/div.
Now approximately 2 signal periods should be visible on the screen.
Press 1kHz/1MHz pushbutton (in!).
Set time base to 0.5 μ s position.
Check 1MHz calibrator signal.



Please note: Neither the calibrator frequency nor the pulse duty factor are specified.

(38) Trigger Filter Check.

Set time base to 1ms/div.
Connect a 1kHz sinewave signal of 40mVpp amplitude to input CH I and check for full screen deflection.
Set input attenuator CH I to 50mV/div and check for 8mm display height.
Select trigger coupling from AC to DC and LF. The signal must always trigger.
Set sinewave generator to 50kHz and 40mV output amplitude and check for 8mm display height.
Select trigger coupling from AC to DC. The signal must always trigger.
Select LF trigger coupling. Now the signal should not trigger.

(39) Triggerbandwidth Check.

Set time base to 0.05 μ s/div, time base variable to CAL position.
Set input coupling switch CH I to DC.
Set trigger coupling to AC.
Release AUTO/NORM pushbutton (out!).
Set input attenuator CH I to 5mV/div.
Connect a 100MHz sinewave signal to input CH I.
Adjust generator output for 5mm display height.
The signal must be triggered.

(40) External Trigger Check.

Set time base to 20 μ s/div.
Set input attenuator CH I to 0.1V/div.
Connect a 50 kHz sinewave signal via a 50-Ohm through terminator with an amplitude of 280mVpp (100mVrms) to input CH I and check for 2.8div display height.
Set LEVEL to midrange position.
Check that the Trigger-LED is ON.
Press EXT. pushbutton. The Trigger-LED (TR) should now be OFF.

Set input coupling CH I to GD.
Remove signal cable from input CH I and connect it to TRIG.INP. socket. Do not change generator settings.
Now the Trigger-LED should be ON again.

(41) Video Trigger Check.

Set CH I input coupling switch to DC.
Connect video signal with positiv sync. pulses to input CH I.
Adjust input attenuator switch CH I for 1 div display amplitude of video signal.
Set time base to 5ms/div (time base \geq 1ms/div = frame triggering).
Set trigger coupling switch to TV.
Check that trigger starts with vertical sync. pulses.
Now approx. 2.5 frames should be visible.
Change polarity of video signal.
Press SLOPE pushbutton (in!).
Again approx. 2.5 frames should be displayed triggered.
Set time base to 20 μ s/div (time base range 0.5ms/div - 0.1 μ s/div = line triggering).
Recheck trigger SLOPE pushbutton procedure, using video signal with polarity change.



Note: *Invert pushbutton does not affect trigger polarity.*

HAMEG[®] **Instruments**

Oscilloscopes

Multimeters

Counters

Frequency Synthesizers

Generators

R- and LC-Meters

Spectrum Analyzers

Power Supplies

Curve Tracers

Time Standards

4S-0303-04E0

HAMEG GmbH

Industriestraße 6

D-63533 Mainhausen

Telefon: +49 (0) 6182 / 800-0

Telefax: +49 (0) 6182 / 800-100

E-mail: sales@hameg.de

service@hameg.de

Internet:

www.hameg.de

Printed in Germany